

# LIVART Office

CATALOGUE 2026



**LIVART Office**

CREATIVE Office... LIVART Office



오피스를 오피스답게 만듭니다.  
기본을 아는 사람들이 만드는 따뜻한 공간,  
우리는 당신의 작은 움직임까지 고려한 '오피스 테일러'입니다.

We make your office space look authentic. Also, we, who focus on the basics, create a cozy office environment. We are an office tailor who designs the space to even make your getting up and extending your arms on the desk easier or more convenient.

### Creative Office

효율성과 기능성을 넘어 창의적인 아이디어가 강조되고 있습니다.  
크리에이티브 오피스를 위한 다양한 제품을 만나보세요.  
Beyond efficiency and functionality, creative ideas are being emphasized.  
Meet a various range of products for creative offices.

### Communication

다양한 방식의 소통을 지원하는 크리에이티브 오피스  
원활한 소통은 크리에이티브 오피스가 기능하기 위한 가장 기본적인 원칙입니다.  
Creative office that supports communication in various ways  
Smooth communication is the most basic principle for the creative office to function.

### Agile

변화에 민첩하게 대응할 수 있는 크리에이티브 오피스  
변화의 속도는 점점 더 빨라지고 있습니다.  
Creative office that is agile enough to respond to these change  
The speed of change is getting faster.

### Diversity

다양한 업무 형태를 지원하는 크리에이티브 오피스  
개인의 특성을 존중하고, 다양성을 활용하는 것이 기업의 핵심이 되고 있습니다.  
Creative office that supports a wide variety of business types  
Respecting individual characteristics and leveraging diversity are becoming core value of a company.

## 더 나은 오피스 공간만을 생각하는 리바트오피스

LIVART OFFICE which devotes to provide better workplace

하루 대부분의 시간을 보내는 사무공간에서 사용자가 더 행복하고 값진 경험을 가질 수 있는 방법을 고민합니다. 우리는 사용자의 사무환경이 더 가치 있고, 본질에 집중하며, 진정성 있는 제품으로 채워질 수 있도록 리바트의 40년 노하우로 공간을 완성합니다.

We are thinking about how the users could be more happy and have valuable experience in the workplace where they spend most of the day. We complete the workspace with LIVART's 40 years of accumulated know-how and ensure that the office environment of the user can be more valuable, be focused on the essence and be filled with thoughtful products.

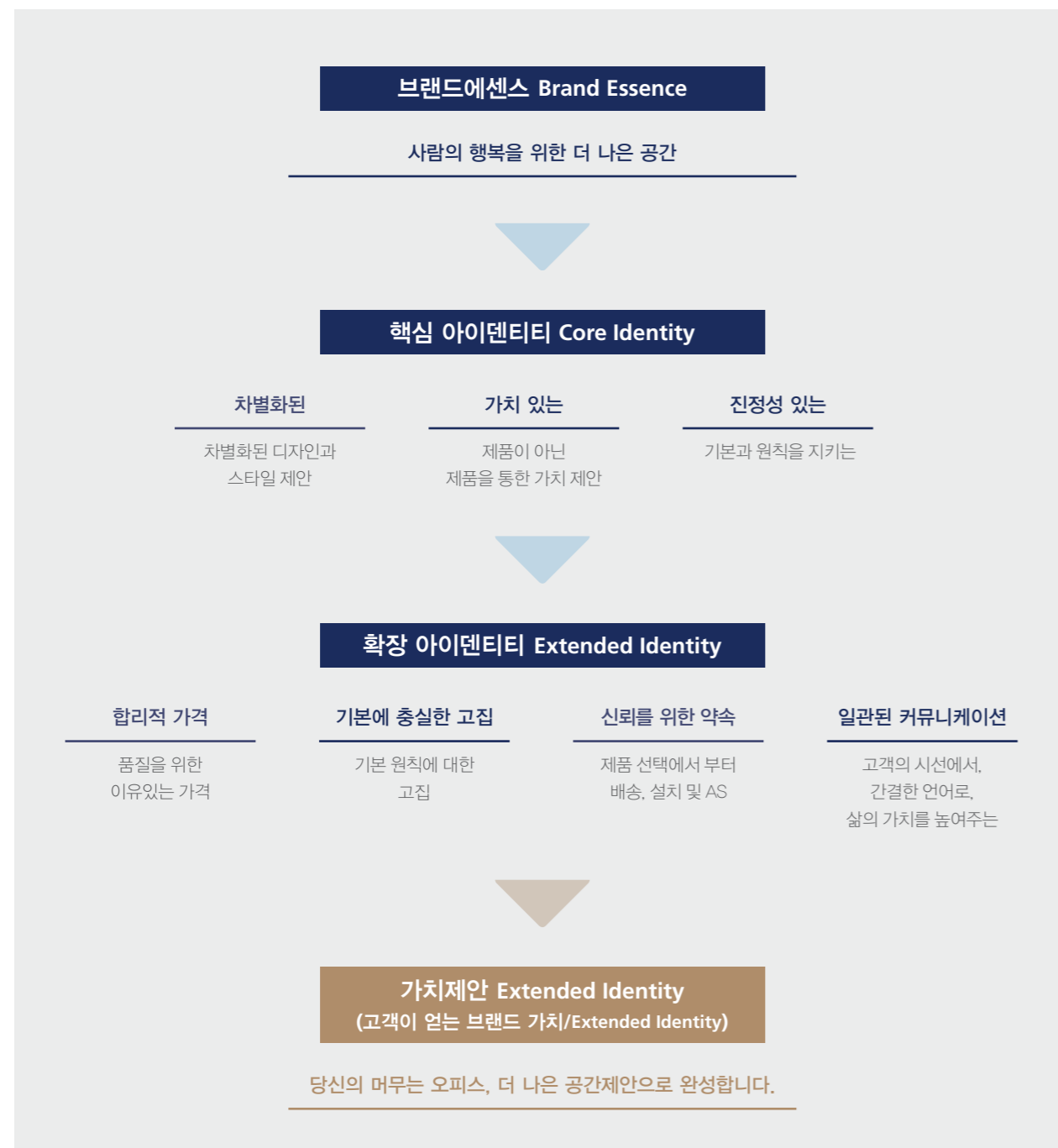

## 리바트오피스만의 고객을 위한 3가지 약속

3 promises of the LIVART OFFICE for customers

고객이 감동하는 쾌적한 생활환경을 조성하고 환경을 보존하는 현대리바트!

현대리바트라는 이름, 그것은 품질에 대한 신뢰입니다.

‘가구에 영혼을 불어넣는 일’, 현대리바트는 그것을 디자인이라 말합니다.

Hyundai LIVART creates a pleasant living environment and preserves the environment for its customers!

The name Hyundai LIVART, it symbolizes trust in quality.

“Bringing souls to furniture,” Hyundai Livart calls it design.

### ECO LIVART

현대리바트는  
가구 브랜드이기 전에  
친환경 브랜드입니다.

Hyundai LIVART is not a just normal furniture brand, but is an eco-friendly furniture brand.



#### 국내가구업계 최초 환경표지인증 획득 The Industry's First Eco-Label

현대리바트는 끊임없는 친환경 연구와 기술개발로 국내 가구업계 최초로 환경표지인증(환경마크)을 획득하였습니다. 앞으로도 현대리바트는 건강한 가구 생산으로 친환경 기업의 리더로서 그 역할을 다할 것입니다.

### QUALITY LIVART

최고의 품질이 아니면  
현대리바트의 이름을  
허락하지 않습니다.

We do not allow the name of Hyundai LIVART unless it is of the highest quality.



#### 퀄리티 리더 철학

#### Quality Leader Philosophy

현대리바트는 환경을 위한 기술 개발과 품질 경영의 적극 실현을 통해 ‘고객의 삶의 공간을 예술로 디자인’하는 사명을 달성하여 21세기를 선도하는 세계 일류기업을 실현하고자 합니다.

### DESIGN LIVART

간결함으로  
진정성을 담은 디자인을  
추구합니다.

We pursue the design with simplicity and sincerity.



#### 트렌드 선도 디자인

#### Trendsetting Designs

빠르게 변화하는 라이프 스타일을 앞서 제안하고 고객이 원하는 가치를 실현하고자 매년 디자인연구소를 통해 가구 디자인 트렌드를 발표하고 있으며, 고객이 더 나은 공간을 행복하게 경험하도록 진심과 디테일을 담은 디자인을 추구합니다.

# Contents

리바트오피스 브랜드 방향성	2
Contents	6

## OFFICE WORKPLACE

### SYSTEM

E-MOTION SPINE <b>NEW</b>	10
E-MOTION DESK	16
Voluto	22
Easy Linker	30
Lite Space	42

### COMMON

Common	50
Accessories	58

### PANEL

30T Partition	62
---------------	----

## Executive

### VENEER

RESERVA	70
EX9 900 Group	74

### LAMINATE

CUERNO	80
Office-One	86
MONTER	96
MOTION DESK	102

## OFFICE TABLE

### CONFERENCE

EC9 900 Group	108
HC7 700 Group	112
HC5 500 Group(조합형)	116
HC5 500 Group(독립형)	120
Voluto Conference	124
Office-One Conference	128
Hub-T	130
Wireless Meeting Solution	136

### SEMINAR

SWING	140
CLECS	142

## OFFICE SEATING

### EXECUTIVE

VALIOSO	148
S900G	149
ARCO EX <b>NEW</b>	150
EGARD	151

### TASK

TECHNIC FLOW <b>NEW</b>	158
TECHNIC	159
ARCO	160
T353G	161
ASCENT PLUS <b>NEW</b>	162
ASCENT	163
BALANCE	164
NEW BOOST <b>NEW</b>	165

### MULTI-USE

mauve	170
Union Variety	171
Grab <b>NEW</b>	172
Vato	173
SEMINAR	174
JOEL	175
MEDITIO	175
RIFF	176
PRONTO	176
FIT	177
Comfy	177

## Office PUBLIC

### AMENITY

GROOB <b>NEW</b>	188
Palette	192
OH-HA	200
C600 Group	206
maas	216
nut	222
RS2 201 Group	228
RS1 100 Group	230
Phone-Booth	234

### SOFA

EX900 Group	238
Bake	238
RS7 700 Group	239
RS7 701 Group	239
Hermoso	240
Nieve	240
3200 Group	241
RS3 300 Group	241
Mocha	242
LH 200 Group	242

### AMENITY TABLE

Sofa Table(Low-Height)	243
Sofa Table(Mid-Height)	244
Color-Base Table	244
Wood Table	244
Multi-Purpose Table	245
HAWORTH	246

### OFFICE MATERIALS

252

### BUSINESS AREA

254

# Office Workplace

## SYSTEM



E-MOTION SPINE 10



E-MOTION DESK 16



Voluto 22



Easy Linker 30

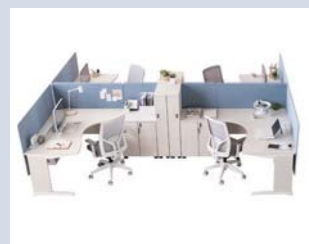

Lite Space 42

## COMMON



Common 50



Accessories 58

## PANEL



30T Partition 62

# E-MOTION SPINE 이모션 스파인

NEW



Customizable Modular Cable Solutions

## 맞춤형 조합이 가능한 모듈형 케이블 솔루션

사무 환경에 최적화된 배선 정리 시스템을 제공하며,  
자유로운 레이아웃과 맞춤형 옵션으로 사용성을 극대화합니다.

This series offers a cable management system optimized for office environments,  
maximizing usability with flexible layouts and customizable options.



# E-MOTION SPINE



## 01. 내부 케이블 솔루션 Hidden Cable Management Solution

스파인 내부로 배선을 수납하여 깔끔하고 안전한 바닥 환경을 제공합니다.  
Wiring is routed inside the Spine, providing a clean and safe floor environment.



## 02. 자유로운 레이아웃 Flexible Layout

자유로운 각도 조절로 창의적인 레이아웃을 구현합니다.  
The flexible angle adjustment enables creative layouts.

## 03. 배선 연결용 특수 커넥터 Special connector for wiring connections

회전 힌지 설계를 통해 최대 3개 유닛까지 배선을 연결할 수 있습니다. (특허 출원)  
Up to three units can be connected via wiring through the rotary hinge design. (Patent application)

## 04. 다목적 회의테이블 Multi-Purpose Conference Table

회의테이블로 다목적 미팅 공간을 제공합니다.  
\*클램프형 : 올라 멀티탭, 모니터암 등  
Provides a versatile meeting space with a conference table.  
\* Clamp-on type : iHola power strip, monitor arm, etc.

# Module Variation











## E-MOTION SPINE - ALT1

인원과 공간에 맞춰 각도와 배치를 자유롭게 변경할 수 있습니다.  
책상을 엇갈리게 배치하여 업무 간섭을 줄이고 개인 몰입도를 제공합니다.

The layout and angles can be freely adjusted to suit different team sizes and spatial requirements. Desks can be arranged in a staggered configuration to minimize work interference and enhance individual focus.



### ITEM

 모션 라이트 (W1600) H061773 6EA	 펠트 스크린 H056203 6EA	 원형테이블 H056706 1EA	 스툴 H056693 & H056694 2EA & 1EA		
 연결형 바디 (W1200) H065250 5EA	 단독형 바디 H065260 2EA	 아크릴 스크린 (일반형) H065273 3EA	 PET 스크린 (높은형) H065264 2EA	 거치형 수납선반 H061978 6EA	 600용 수납장 H065258 4EA

## E-MOTION SPINE - ALT2

선반 테이블에서 간단한 소통과 빠른 자료 공유가 가능합니다.  
미니멀한 구성으로 개별 업무와 협업 간 유연한 전환을 지원합니다.

The shelf table enables quick communication and easy sharing of materials. Its minimalist design supports seamless transitions between individual tasks and collaborative work.



### ITEM

 아크 (W1600) H058715 4EA	 스크린 H058726 4EA	 측면 스크린 (L&R) H058732 & H058734 2EA & 2EA	 스툴 H056694 2EA	
 연결형 바디 (W1200) H065249 1EA	 연결형 바디 (W1600) H067106 2EA	 회의용 선반 H065255 1EA	 PET 스크린 (일반형) H065265 2EA	 거치형 수납선반 H061977 4EA

## E-MOTION SPINE

### Body 바디



W1200 연결형 바디 W1200 Connected Body  
Color. GRG / SBK / YE / GN  
1200 · 65(220) · 653



W1600 연결형 바디 W1600 Connected Body  
Color. GRG / SBK  
1600 · 65(220) · 653



W1800 연결형 바디 W1800 Connected Body  
Color. GRG / SBK  
1800 · 65(220) · 653



W1200 연결형 바디(멀티탭)  
W1200 Connected Body(Multi-tap)  
Color. GRG / SBK / YE / GN  
1200 · 65(220) · 653



W1200 단독형 바디(멀티탭)  
W1200 Standalone Body(Multi-tap)  
Color. GRG / SBK / YE / GN  
1200 · 65(390) · 653

#### BODY

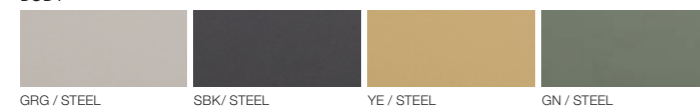

## E-MOTION SPINE

### Option 옵션



조합형 회의테이블  
Combination Conference Table  
Color . SS / SW / NW  
1200 · 790 · 730



회의용 선반  
Conference Shelf  
Color . SS / SW / NW  
1090 · 390 · 79



W600 / W400 수납장  
W600/ W400 Unit Storage  
Color . SS / SW / NW / NW+GRG  
544/344 · 232 · 290



PET 스크린 PET Screen  
Color . BE / DG  
일반형 : 800 / 1200 / 1600 · 50 · 470  
높은형 : 1200 · 50 · 670



아크릴 스크린 Acrylic Screen  
Color . WH / DB / VT / YE  
일반형 : 800 / 1200 / 1600 · 50 · 470  
높은형 : 1200 · 50 · 670  
\* VT / YE : 높은형 한정 컬러



거치형 수납선반 Wall-mounted Storage Shelf  
Color . GRG / SBK  
344 · 140 · 180



스파인 케이블 매니지먼트  
SPINE Cable Management  
Color . GY / SBK  
70 · 48 · 1310



안전각  
Stabilizer  
Color . SBK  
390 · 60 · 27(2EA)



엔드 마감캡  
End Finished Cap  
Color . GRG / SBK  
50 · 26 · 126(2EA)



올라 멀티탭  
iHola Power Strip  
Color. SBK  
154 · 58 · 60

#### CABINET/SHELF



#### SCREEN(PET)



#### SCREEN(Acrylic)



# E-MOTION DESK 이모션 데스크



Unique Premium Motion Desk Series

## 유니크한 프리미엄 모션데스크 시리즈

유니크한 디자인으로 개인의 몰입과 탄력적 협업이 가능한 유연한 업무 공간을 제안하고, 사용자가 만족감을 느낄 수 있는 프리미엄급 모션데스크 시리즈입니다.

This series features a unique design that facilitates immersive personal work and flexible collaborative spaces, offering a premium motion desk series that ensures user satisfaction.



시그니처 포레, 시그니처 아크, 아크(SS), 포레(SS), 스크린

# E-MOTION DESK



## 01. 깔끔한 디자인의 컨트롤러 A Sleek Controller

엣지면에서 깔끔하게 떨어지는 디자인의 컨트롤러로, 하부 클릭 버튼 방식을 통해 높이 조절이 가능합니다.

Featuring a sleek & click controller with a clean drop-off edge, this design allows for height adjustment via a lower click-button mechanism.

## 02. 자연 모티브 디자인 Designs Inspired by Nature

자연의 형상에서 영감을 받은 디자인을 통해 기존과 차별화된 새로운 룩을 제안합니다.

Inspired by natural forms, the design suggests a distinctive new look that sets it apart from conventional styles.



## 03. 깔끔한 배선 정리 Cable Management Solutions

리바트만의 케이블 매니지먼트를 통해 모션데스크의 배선을 깔끔하게 정리해 줍니다.

LIVART's exclusive cable management system neatly organizes the wiring of the motion desk.



## 04. 곡선형 스크린 Curved Screen

전면에는 모니터암을 위한 간격이 있어 편리함을 주고, 측면은 완전 밀착되어 안정감을 제공합니다.

The front features a space for a monitor arm, adding convenience, while the sides fit snugly against the surface, providing stability.

# Module Variation



## E-MOTION DESK - ALT1

### Floor Plan

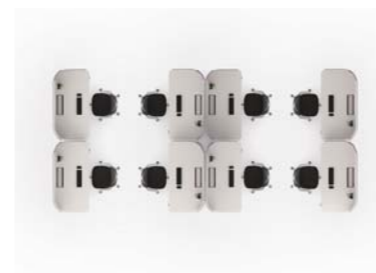

### ITEM



## Module Variation

### E-MOTION DESK & SPINE Set



### E-MOTION DESK 1



### E-MOTION DESK 2



#### ITEM



책상(W1600)  
H058699  
1EA

스크린  
H058725  
1EA

PC 행어  
H056384  
1EA

케이블 기본타입  
H057573  
1EA

#### ITEM



책상(W1600)  
H058714  
1EA

하부장  
H059774  
1EA

스크린  
H058726  
1EA

측면 스크린  
H058732  
1EA

## E-MOTION DESK

### Signature Desk 시그니처 데스크

\* 오더메이드 제품으로 영업팀 별도 문의



포레 Fore  
Color . GN

1600 · 790 · 690-1120



아크 Arc  
Color . VI

1600 · 790 · 690-1120

#### Color/Material



### Desk 데스크



포레 Fore  
Color . SW / SS / NW

1400 / 1600 / 1800 · 790 · 690-1120



아크 Arc  
Color . SW / SS / NW  
Leg. IV / SBK

1400 / 1600 / 1800 · 790 · 690-1120



PC 행어 PC Hanger  
Color. LG / SBK

413 · 188 · 500  
\* 160 · 370 · 380 이하 수납 가능 (가로 · 깊이 · 높이)



하부장 Lower Part Storage  
Color. GY

1010 · 395 · 570



스크린 Screen  
Color. BE / DG / GN / VI

1516.5 · 750 · 16  
1716.5 · 750 · 16  
1916.5 · 750 · 16



측면 스크린 Side Type Screen  
Color. BE / DG

825 · 700 · 16  
\* 좌/우형 운영

#### Color/Material



# Voluto 볼루토



Workzone series supporting different types of work

다양한 업무 유형을 지원하는 워크존 시리즈

레이아웃 변경이 용이한 프레임 모듈과 교체가 편리한 액세서리 옵션을 통해 업무 형태와 공간 규모에 맞춰 다양한 워크스테이션 공간을 구성할 수 있는 시리즈입니다.

This series allows for the creation of various workstation spaces tailored to the type of work and space dimensions, featuring frame modules with easy layout changes and accessory options that are convenient to replace.



## Voluto WORKSTATION

자율 좌석제 혹은 고정 좌석제와 같은 다양한 업무 형태 활용이 가능합니다.

모듈을 통해 간단히 레이아웃 변경이 가능하며, 다양한 옵션을 통해 사용자의 편의를 지원합니다.

It supports various work modes such as hot-desking and assigned seating.

Layout changes can be easily made through modules, and a variety of options enhance user convenience.



W2400 워크스테이션 액세서리바형 (WOA+GN), 하부 엔드 스크린, 하부스크린, 액세서리



W2800 워크스테이션 액세서리바형 (UOA+SBK), 하부 엔드 스크린, 하부스크린, 액세서리



### 01. 맞춤형 업무 환경 Customized Workstation

전면 스크린과 액세서리 바 조합으로 원하는 업무 환경을 조성할 수 있습니다.  
Various accessory options that are easy to install and freely usable.



### 02. 탈부착형 스크린 Detachable Screen

탈부착과 교체가 용이한 스크린으로 시선과 소음을 차단해줍니다.  
A screen that blocks sight and noise, and is easy to detach and replace.



### 03. 양방향 오픈형 덕트 커버 Two-Way Open Duct Cover

양방향 오픈형 덕트 커버로 양측 사용자 모두에게 편리함을 제공합니다.  
A bi-directional open-type duct cover that provides convenience to users on both sides.



### 04. 대용량 덕트 공간 Large-Capacity Duct Space

대용량 덕트 공간은 5+1구/2USB 콘센트 사용이 가능합니다.  
A large duct space providing ample power supply, offering 5+1 sockets and 2 USB ports per person.



### 05. 클램프 액세서리 지원 Support for Clamp Accessories

클램프 타입의 액세서리 사용이 가능합니다.  
Options for clamp-type and ready-made accessories are available.



### 06. 탈부착형 마감캡 Detachable Logo-Finished Cap

로고 마감캡 탈부착 가능으로, 연속 배치시에 자연스러운 수평 배선 연결이 가능합니다.  
A detachable logo-finished cap allows for a natural connection of cables when tables are arranged continuously.

## Module Variation

### Voluto 1

둥근 다릿발 디자인과 따뜻한 감성의 펠트 소재로 새로운 형태의 업무공간 연출이 가능한 워크스테이션

Workstation that creates a new type of workspace with its rounded legs design and the warm feel of felt material



#### Desk Set



책상(W1600)  
H045917  
1EA

ASCENT PLUS(미들백형)  
H061137  
2EA

#### Addition Item

하부 엔드 스크린 H043768  
하부 스크린 H043764  
멀티탭 H043151

### Voluto 2

따뜻한 컬러와 펠트 소재 조합으로 공간에 활기를 채워 활발한 소통과 협업을 촉진하는 워크스테이션  
Workstation that enlivens the space with warm colors and felt material, fostering active communication and collaboration



#### Desk Set



책상(W2800)  
H045925  
1EA

ASCENT PLUS(미들백형)  
H061138  
4EA

#### Addition Item

하부 엔드 스크린 H043768  
하부 스크린 H043762  
멀티탭 H043151

## Module Variation

### Voluto 3

캐주얼한 디자인의 낮은 스크린과 액세서리를 활용하여 쾌적하고 편리함을 갖춘 소통형 워크스테이션

Communication-oriented workstation equipped with comfort and convenience, utilizing a casual low screen design and accessories



#### Desk Set



책상(W2400 액세서리바형)  
H045893  
1EA

ASCENT PLUS(미들백형)  
H061138  
4EA

#### Addition Item

하부 엔드 스크린 H043768  
하부 스크린 H043766  
노트북 거치대 H043786  
펜꽂이 H043783  
펜트레이 H043784

### Voluto 4

높은 스크린으로 몰입형 업무를 지원하며, 모니터암과 펜트레이 액세서리 구성의 편리함을 갖춘 워크스테이션

Workstation that supports immersive work with high screens, equipped with the convenience of a monitor arm and a pen tray accessory configuration



#### Desk Set



책상(W3200 액세서리바형)  
H045931  
1EA

ASCENT PLUS(미들백형)  
H061139  
4EA

#### Addition Item

하부 엔드 스크린 H043769  
하부 스크린 H043765  
모니터암 H043790  
엔드 스크린(소) H045942

# Voluto

## Workstation 워크스테이션

\* SW색상 우드엣지 마감



**W1400 일반형 W1400 General Type**  
Color. SW / WOA / UOA  
Frame. SW / GN / SBK  
1400 · 1500 · 730



**W1600 일반형 W1600 General Type**  
Color. SW / WOA / UOA  
Frame. SW / GN / SBK  
1600 · 1500 · 730



**W2400 일반형 W2400 General Type**  
Color. SW / WOA / UOA  
Frame. SW / GN / SBK  
2400 · 1500 · 730



**W2800 일반형 W2800 General Type**  
Color. SW / WOA / UOA  
Frame. SW / GN / SBK  
2800 · 1500 · 730



**W3200 일반형 W3200 General Type**  
Color. SW / WOA / UOA  
Frame. SW / GN / SBK  
3200 · 1500 · 730

## Workstation 워크스테이션-액세서리바형

\* SW색상 우드엣지 마감



**W1400 액세서리바형 W1400 Accessory Bar Type**  
Color. SW / WOA / UOA  
Frame. SW / GN / SBK  
1400 · 1500 · 730(1270)  
\* 상단 액세서리 바 + 펠트 높이 = H 540



**W1600 액세서리바형 W1600 Accessory Bar Type**  
Color. SW / WOA / UOA  
Frame. SW / GN / SBK  
1600 · 1500 · 730(1270)  
\* 상단 액세서리 바 + 펠트 높이 = H 540



**W2400 액세서리바형 W2400 Accessory Bar Type**  
Color. SW / WOA / UOA  
Frame. SW / GN / SBK  
2400 · 1500 · 730(1130)  
\* 상단 액세서리 바 + 펠트 높이 = H 400



**W2800 액세서리바형 W2800 Accessory Bar Type**  
Color. SW / WOA / UOA  
Frame. SW / GN / SBK  
2800 · 1500 · 730(1270)  
\* 상단 액세서리 바 + 펠트 높이 = H 540



**W3200 액세서리바형 W3200 Accessory Bar Type**  
Color. SW / WOA / UOA  
Frame. SW / GN / SBK  
3200 · 1500 · 730(1270)  
\* 상단 액세서리 바 + 펠트 높이 = H 540

### Color/Material

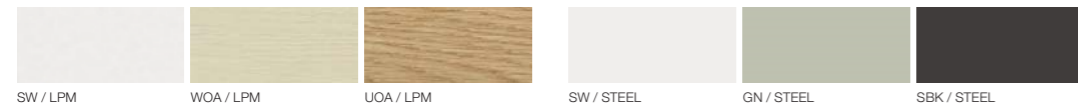

# Voluto

## Accessory 액세서리



**수직배선 홀더 Common Vertical Duct**  
Color. SW / GY / SBK  
550 · 75 · 60  
\* 볼루토 & 이지링커 공용 / 하부 다릿발 결합용



**노트북 거치대 Laptop Holder**  
Color. Silver  
240 · 248 · 129



**펜 꽃이 Pen Holder**  
Color. LG  
63 · 55 · 93



**펜 트레이 Pen Tray**  
Color. LG  
240 · 85 · 61



**모니터 받침대 Monitor Stand**  
Color. LG  
416 · 222 · 63



**모니터암 Monitor Arm**  
Color. BK  
357 · 301 · 115



**노트북 거치대 Laptop Holder**  
Color. Silver  
310 · 218 · 39

## Screen 스크린



**엔드 스크린(대) End Screen(L)**  
Color. WG / DG  
Bracket. SW / GY / SBK  
1500 · 820 · 12  
\*SBK 브라켓은 DG 매칭



**엔드 스크린(소) End Screen(S)**  
Color. WG / DG  
Bracket. SW / GY / SBK  
1500 · 750 · 12  
\*SBK 브라켓은 DG 매칭



**하부 스크린 Lower Screen**  
Color. BE / DG  
1040/1240/2040 · 219 · 9



**하부 엔드 스크린 Lower End Screen**  
Color. BE / DG  
707 · 295 · 9



**사이드 스크린(펠트) Side Screen(Felt)**  
Color. BE / DG  
Bracket. SW / SBK  
600 · 115 · 397  
\*SBK 브라켓은 DG 매칭



**사이드 스크린(아크릴) Side Screen(Acrylic)**  
Color. SW / OR / DB  
Bracket. SW / SBK  
600 · 115 · 397  
\*SBK 브라켓은 DB 매칭

### Color/Material

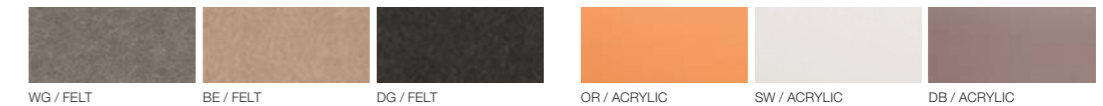

# Easy Linker 이지링커



Sensuous and Comfortable living office

## 편안하고 감각적인 리빙오피스

가정에서 일하듯 편안하고 따뜻한 사무공간의 새로운 트렌드.  
간편한 조립성과 자유로운 레이아웃 구성으로 공간의 활용성을 극대화합니다.  
개방적인 협업 업무 환경에 적합한 스마트 오피스를 제안합니다.  
Warm and cozy new trend workplace felt like working at home.  
Easy assembling and various layout maximize space utilization.  
Suggests smart office for open and cooperative work environment.



## Easy Linker Desk

독특한 다릿발과 차분한 컬러로 오피스 공간을 한층 부드럽게 만들어줍니다.  
편리함과 깔끔함으로 사무공간의 효율성과 편안함을 동시에 선사합니다.

Unique legs and tone down color provides softer atmosphere to workplace.  
Suggests efficient utilization and comfort at the same time by simple and convenient design.



120도형 책상(SW), 120도형 스크린, 삼각 철제 패널



전동 데스크(SW), 스크린



### 01. 소프트 우레탄 팔 패드 Soft Urethane Arm Pad

팔이 닿는 면에 부드러운 소재의 우레탄 패드를 적용했습니다.  
A soft urethane is applied to the surface within arm's reach for comfort.



### 02. 상판 일체형 덕트 커버 Duct Cover Integrated with Top Panel

상판과 동일 사양의 덕트 커버를 통해 일체감을 완성했습니다.  
A duct cover of the same specification as the desktop is used to achieve a unified look.



### 03. 마그네틱 핀업 철제 상부장 Magnetic Pin-Up Steel Upper Cabinet

마그네틱 핀업 가능한 걸면과 수납력을 높인 내부로 구성된 철제 상부장입니다.  
It is a metal hutch that can be used with magnetic pins on the exterior and has enhanced storage capacity inside.



### 04. 수평 높이 조절 레벨러 Horizontal Adjustment Leveler

다릿발 레벨러 기능으로 수평 높이가 조절이 가능합니다.  
The desk legs have leveler functions, allowing for adjustable height.



### 05. 무버블 데스크 캐스터 기능 Movable Desk Caster

캐스터 다릿발로 이동이 편리하며, 잠금 기능으로 고정이 가능합니다. (무버블 데스크)  
The desk is easy to move with caster legs and can be locked in place with a locking feature (movable desk).

## Easy Linker Motion Desk

활동적이고 건강한 사무 환경을 위한 높이 조절 데스크를 제안합니다.

사용자의 건강과 업무 형태까지 고려한 높이 조절형 데스크로 오피스의 분위기를 바꿔보세요.

We suggest height-adjustable desks for an active and healthy office environment.

Transform the office atmosphere with height-adjustable desks that consider the user's health and work style.

### 모션 데스크 작동법 Motion Desk Operation Manual

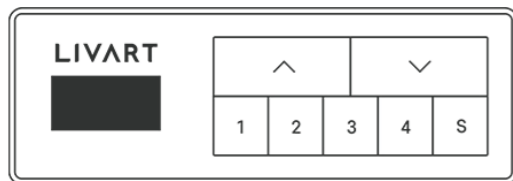

#### 높낮이 저장 방법 How to Save the Height Setting

- 1 [↑ ↓] 버튼으로 높이를 설정합니다.
  - 2 [S] 버튼을 누릅니다.
  - 3 [1 2 3 4] 중 원하는 버튼을 누르면 저장됩니다.
- 1 Adjust the height using the up and down buttons.  
2 Press S button.  
3 Press the desired button among 1, 2, 3, or 4 to save the setting.

#### 초기화 방법 How to Reset

- 1 [↓] 버튼을 10초간 눌러줍니다.
  - 2 초기화가 진행됩니다.
- 1 Press and hold the down button for 10 seconds.  
2 The reset process will begin.

### 이지링커 데스크 상세 정보 Detailed Information about Easy Linker Desk

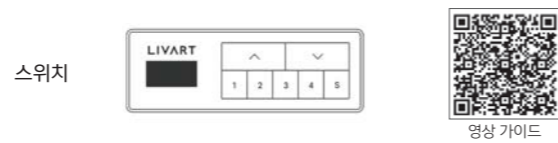

모터	듀얼
높이	618~1268mm
속도	40mm/s
최대하중	125kg



#### 01. LCD 높이조절 스위치 LCD Height Adjustment Button

LCD DISPLAY 방식의 높이조절 스위치는 4개의 높이를 기억하는 메모리 버튼이 있습니다.  
The LCD DISPLAY type height adjustment switch has a memory button that remembers four different heights.



#### 02. 최대 125kg 지지 칼럼 Up to 125kg Support Columns

3단 칼럼 2모터를 사용하여 부드럽게 사용할 수 있고, 최대 125kg의 지지 하중으로 안정성을 보장합니다.  
Utilizing a 3-stage column and dual motors, the desk operates smoothly and ensures stability with a maximum load capacity of 125kg.

## Easy Linker Desk with Side Cabinet

많은 서적 및 서류를 보관해야 하는 업무에 최적화된 데스크 솔루션입니다.

사이즈가 큰 전자 제품도 수납할 수 있는 아이템으로 편리성을 높였습니다.

This is a desk solution optimized for tasks that require storing numerous books and documents.

It includes items that can store large electronic devices, enhancing convenience.

### 효율적 수납 책상세트 Efficient Storage Desk Set



#### 01. 사이드 상하부장을 활용한 수납공간 Storage Space Utilizing the Side Upper and Lower Cabinets

편수형 책상세트는 수납과 공간의 효율성을 극대화 합니다.  
The modular desk set maximizes storage and spatial efficiency.

#### 02. 철재 슬라이딩 도어 Steel Sliding Door

철재 슬라이딩 도어 엣지는 손잡이로 활용 가능하며, 메모를 부착할 수 있습니다.  
The metal sliding door edge can be used as a handle and allows for attaching notes.

#### 03. 하부 수납 솔루션 Lower Storage Solution

하부 PC 보관함으로 효율적인 수납과 깔끔한 공간 연출이 가능합니다.  
The lower PC storage compartment allows for efficient storage and creates a neat space.

### 깔끔한 배선 솔루션 Cable Management Solutions

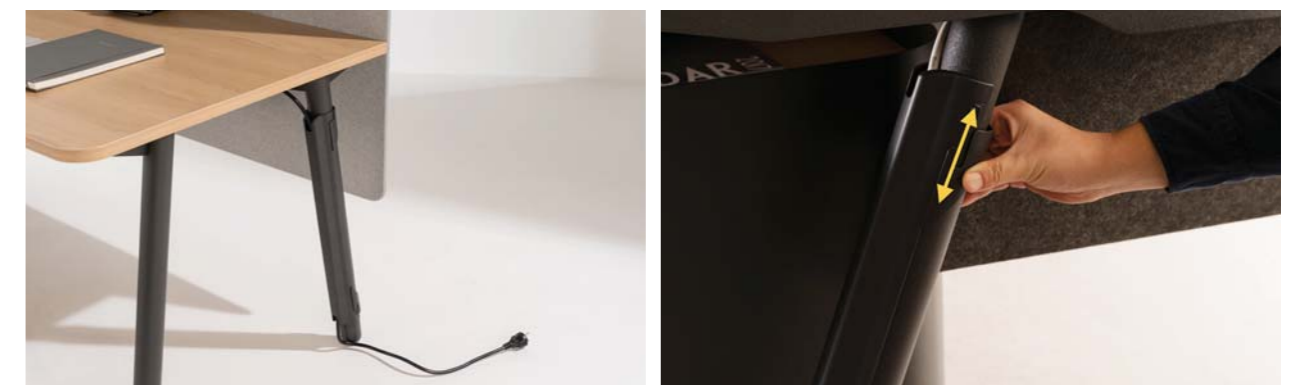

#### 01. 수직 배선 덕트 Vertical Wiring Duct

수직 배선 덕트로 전선 정리가 용이하며 슬라이딩 클립 방식으로 쉽게 이탈되지 않습니다.  
The vertical wiring duct makes cable management easy, and the sliding clip mechanism prevents it from easily detaching.

## Module Variation

### Easy Linker 1

원형의 부드러운 다릿발 디자인으로 캐주얼한 업무공간 연출이 가능하고 우레탄 암패드 옵션으로 사용성이 편리한 스탠다드 워크스테이션

Standard workstation featuring a round, soft-legged design for a casual workspace setup, enhanced with a urethane arm pad option for convenient usability



#### ITEM



### Easy Linker 2

옷장과 멀티장을 활용하여 개인 수납 공간을 확보하며, 확장된 작업 영역으로 원활한 소통을 촉진하는 워크스테이션

Workstation that facilitates personal storage space using a wardrobe and a multi-cabinet, promoting smooth communication through an extended work area



#### ITEM



## Module Variation

### Easy Linker 3

옷장을 활용한 다양한 수납 기능과 측면 파티션 역할이 가능한 효율적이고 산뜻한 컬러 조합의 워크스테이션

Workstation equipped with various storage features utilizing the wardrobe and capable of serving as a side partition, offering an efficient and refreshing color combination



#### ITEM



### Easy Linker 4

멀티장과 데스크의 연결된 작업 공간을 통해 작업 면적을 확장하고, 옷장과 물품 수납력을 갖춘 워크스테이션

Workstation with an expanded work area through the connected workspace between the multi cabinet and the desk, equipped with a wardrobe and storage capacity



#### ITEM



## Module Variation

### Easy Linker - ALT1

넓은 업무 공간과 효율적인 레이아웃이 가능한  
120도 디자인으로 다양한 배치가 가능한 워크스테이션  
Workstation that offers a wide workspace and an  
efficient layout with a 120-degree design, allowing  
for various configurations



#### ITEM



### Easy Linker - ALT2

옷장과 멀티장을 활용하여 개인 수납 공간과  
PC 보관을 통해 정돈된 관리가 용이한 워크스테이션  
Workstation that facilitates organized  
management with personal storage  
space and PC storage using a wardrobe  
and a multi-cabinet



#### ITEM



## Module Variation

### Easy Linker - ALT3

파티션을 활용하여 공간을 구분하고, 상부와 하부 장을  
활용하여 수납력을 갖춘 워크스테이션  
workstation that uses a partition to divide  
space and utilizes upper and lower cabinets for  
enhanced storage capacity



#### ITEM



### Easy Linker - ALT4

장시간 업무에 집중하는 사용자를 위해 자세를 개선하여  
업무 효율을 높이는 스탠딩 워크스테이션  
Standing workstation designed to improve posture  
for users who concentrate on long hours of work,  
thereby enhancing work efficiency



#### ITEM



# Easy Linker

## Desk 데스크



**일반형/우레탄형 데스크**  
Standard/Urethane Edge Type Desk  
Color. SW / WOA / UOA

1200/1400/1600/1800 · 790 · 730  
\* 5구, 1LAN (덕트 포함)  
\* 5 sockets, 1 LAN (including a duct)



**무버블 일반형/우레탄형 데스크**  
Movable Standard/ Urethane Edge Desk  
Color. SW / WOA / UOA

1400/1600/1800 · 790 · 730  
\* 5구, 1LAN (덕트 포함)  
\* 5 sockets, 1 LAN (including a duct)



**120도형**  
120-Degree Desk  
Color. SW / WOA / UOA

2120 · 1210 · 730  
\* 5구, 1LAN (덕트 포함)  
\* 5 sockets, 1 LAN (including a duct)



**편수형 책상(일반형/우레탄형)**  
Modular Desk(Standard/Urethane)  
Color. SW / WOA

1200/1400/1600/1800 · 790 · 730  
\* 편수형 책상 + PC보관함 +  
(이지링커 확장형) 상부장 + 하부장 세트 구성  
\* PC 보관함, 하부장 별도 주문



**PC 보관함**  
PC Storage  
Color. SW / WOA

770 · 423 · 632



**이지링커 확장형 하부장**  
Easy Linker Lower Part Storage  
Color. SW / WOA

809 · 402 · 632  
\* (좌) 2단 선반 (우) 상하부 서랍



\* 좌형(L Type)

**이지링커 확장형 상부장**  
Easy Linker Expender Upper Part Storage  
Color. SW / WOA (바디) + SW / YE (도어)

1599 · 300 · 568



\* 우형(R Type)

**이지링커 상부장**  
Easy Linker Upper Part Storage  
Color. SW

785 · 350 · 496  
\* SW 한정 운영



**덕트 하우징 / 목재 덕트 커버**  
Cable Manager / Wooden Manager Cover  
Color. (하우징) SW / BK (커버) SW / WOA / UOA

(하우징) 600 · 170 · 170  
\* 멀티탭 5+1구 1LAN 타입



**수직배선 홀더**  
Common Vertical Duct  
Color. SW / GY / SBK

550 · 75 · 60  
\* 블루토 & 이지링커 공용 / 하부 다릿발 결합용



Color/Material  
SW / LPM    WOA / LPM    UOA / LPM

# Easy Linker

## Motion Desk 전동데스크



**전동 데스크 E (일반형/우레탄형)**  
Motion Desk E (Standard/Urethane Type)  
Color. SW / WOA / UOA

1200/1400/1600/1800 · 790 · 618~1268  
\* 순방향 3단  
\* 상판23mm 포함 높이



**순방향 사각 컬럼용**  
For Forward Square Columns Type  
Color. SW / SBK

34 · 50 · 1282  
\* 정방향 컬럼에 적용 가능  
(오피스 이지링커 모션데스크,  
하울 모션데스크 라이트 매칭 가능)

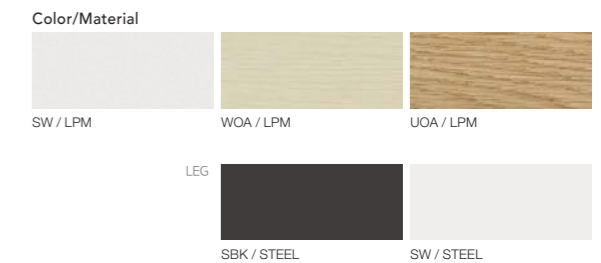

Color/Material  
SW / LPM    WOA / LPM    UOA / LPM  
LEG  
SBK / STEEL    SW / STEEL

# Lite space 라이트 스페이스



Space layout for a flexible work environment

## 유연한 업무환경을 위한 공간 레이아웃

효율적인 공간 활용을 중시하는 오피스 트렌드를 반영한 경제적이고 감각적인 디자인, 가볍고 경쾌한 느낌을 주는 컬러까지 겸비한 합리적인 Lite space를 소개합니다.

We introduce Lite Space, a practical solution which is designed based on today's office design trend, focusing on an efficient and economical space utilization while looking aesthetically pleasing with bright and vibrant colors.



## Lite space Work Station



\* WOA 이미지

### 팀장석 배치 Placing manager desk & seat

구성 : ㄱ자책상 + 보조책상(U형) + 멀티장 or 사이드 책장 + 개인옷장

Composition: L-Shaped Desk + Side Desk(U-Shape) + Multi-Use Cabinet or Side Book Cabinet + Personal Wardrobe



\* SW 이미지

### 양수책상 배치 Placing desk with drawers on both sides

구성 : 양수책상(1200/1400/1600) + 이동식 서랍박스(공용) + 멀티장 or 사이드 책장

Composition: Desk with Drawers on Both Sides (1200/1400/1600) + Movable Drawer(Sharing)  
+ Multi-Use Cabinet or Side Book Cabinet



### 01. 곡선형 디자인 Curved Design

부드러운 곡선 마감 디자인으로 시각적 안정감과 사용상 안락함을 선사합니다.  
A soft urethane is applied to the surface within arm's reach for comfort.



### 02. 두 가지 소재의 다릿발 Legs Made of Two Materials

다릿발은 상부, 하부 철제+중간 측판 목재 적용하여 투톤 느낌으로 제품에 포인트를 주었습니다.  
A soft urethane is applied to the surface within arm's reach for comfort.



### 03. 상판 일체형 덕트 커버 Duct Cover Integrated with Top Panel

상판과 동일 사양의 덕트 커버를 통해 일체감을 완성했습니다.

Complete integration through duct cover with the same specification as the top board.



### 04. 대용량 덕트 박스 Large-Capacity Duct Box

대용량 덕트 박스 적용으로 전선 코드 사용시 편리함 제공, 5구 멀티탭을 통한 개선된 배선 기능을 제공합니다.

Large capacity duct box provides convenience when using electric cables, and improved wiring capabilities with extensions with 5 outlets.



### 05. 다양한 수납 구성 Various Storage Options

사이드장, 사이드 오픈장, 멀티장, 공용 옷장으로 구성되어서 다양하게 사무공간 레이아웃 연출 가능합니다.

It consists of side cabinet, side open cabinet, multi-storage cabinet and sharing wardrobe whose location can be configured to provide various layouts.



### 06. 하부 배선클립 Lower Cable Clips

상판 하부에는 배선클립을 적용하여 배선을 깔끔하게 정리하였습니다.  
Cable or cord clip is attached underneath the upper panel for better cable management.



### 07. 하부 가방걸이 Lower Bag Hanger

가방걸이는 책상 하부에 부착하여 손쉽게 가방을 수납하실 수 있습니다.  
The bag hanger can be attached underneath the desk, providing an easy way for keeping your bag.

## Module Variation

### Lite Space 1

하부 목재와 철제를 활용하여 견고함을 갖춘  
볼드한 디자인으로, 제품의 포인트가 돋보이는  
워크스테이션

Bold design workstation that incorporates both  
wood and metal for durability, highlighting the  
product's features



#### ITEM



책상(W1400) H041509 1EA	서랍박스(3단) H058651 1EA	데스크 스크린(전면) H059624 1EA	데스크 스크린(측면) H059636 1EA	ASCENT H054514 1EA
-----------------------------	----------------------------	-------------------------------	-------------------------------	--------------------------

### Lite Space 2

옷장과 멀티장을 활용하여 개인 수납공간을  
확보하며, 확장된 작업 영역으로 원활한 소통을  
촉진하는 워크스테이션

Workstation that facilitates personal storage  
space using a wardrobe and a multi-cabinet,  
promoting smooth communication through  
an extended work area



#### ITEM



책상(W1600) H041512 1EA	멀티 하부장 H042443 1EA	책상 사이드 테이블 H029955 1EA	옷장 H047305 1EA	데스크 스크린(전면) OSSP50016FHBU*/H017319 1EA	ASCENT H054514 1EA	mauve H045673 1EA
-----------------------------	--------------------------	------------------------------	----------------------	--	--------------------------	-------------------------

## Module Variation

### Lite Space 3

옷장을 활용한 다양한 수납 기능과 측면 파티션  
역할이 가능한 효율적이고 산뜻한 컬러 조합의  
워크스테이션

Workstation equipped with various storage  
features utilizing the wardrobe and capable of  
serving as a side partition, offering an efficient  
and refreshing color combination



#### ITEM



책상(W1600) H041513 1EA	이동서랍(서랍전면 사출) H029942 1EA	옷장 H047315 1EA	펠트 스크린 H059868 1EA	ASCENT H054513 1EA
-----------------------------	---------------------------------	----------------------	--------------------------	--------------------------

### Lite Space 4

멀티장과 데스크의 연결된 작업 공간을 통해 작업  
면적을 확장하고, 옷장과 물품 수납력을 갖춘  
워크스테이션

Workstation with an expanded work area  
through the connected workspace between  
the multi cabinet and the desk, equipped with  
a wardrobe and storage capacity



#### ITEM



책상(W1400) H041510 1EA	서랍박스(3단) H058652 1EA	멀티장 H042447 1EA	30T 파티션(일반형) H009774 1EA	ASCENT H054514 1EA
-----------------------------	----------------------------	-----------------------	--------------------------------	--------------------------

## Module Variation

### Lite Space - ALT1

'ㄱ' 형태로 공간 구획이 용이하며, 옷장과 캐비닛을 연결하여 넓은 작업 공간이 확보되는 부드러운 곡선형 워크스테이션

L-shaped workstation with a smooth curved design that facilitates space division, connecting a wardrobe and a cabinet to secure a wide working area



#### ITEM



### Lite Space - ALT2

옷장과 멀티장을 활용하여 개인 수납공간을 확보하며, 확장된 작업 영역으로 원활한 소통을 촉진하는 워크스테이션

Workstation that utilizes a wardrobe and a multi-cabinet for personal storage space, promoting smooth communication with an extended work area



#### ITEM



## Lite space

### Desk 데스크



#### 일반형 General Type

Color. SW / WOA

1200/1400/1600 · 790 · 730  
\* 5구, 1LAN (덕트 포함)  
\* 5 sockets, 1 LAN (including a duct)



#### ㄱ자형 L-Shaped

Color. SW / WOA

1600 · 1200 · 730  
\* 5구, 1LAN (덕트 포함)  
\* 5 sockets, 1 LAN (including a duct)

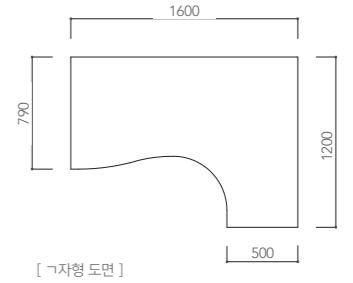

### Storage 스토리지



#### 하부 사이드 캐비닛 오픈형 Under-The-Desk Side Cabinet(Open Type)

Color. SW / WOA

600 · 500 · 730



#### 하부 사이드 캐비닛 Under-The-Desk Side Cabinet

Color. SW / WOA

600 · 500 · 730



#### 하부 멀티장 Under-The-Desk Multi-Storage Cabinet

Color. SW / WOA

790 · 500 · 730



#### 옷장 Wardrobe

Color. SW / WOA

200 · 500 · 1200  
\* 거울, 소품정리 ACC 포함  
\* 높은형 스크린에 호환가능



#### 덕트 하우징 / 목재 덕트 커버 Cable Manager / Wooden Manager Cover

Color. (하우징) SW / BK (커버) SW / WOA / UOA

(하우징) 600 · 170 · 170  
\* 멀티탭 5+1구 1LAN 타입



#### 행잉하부선반 Under Desk Handing Shelf

Color. SW

644 · 245 · 410

# Common 공용

## Drawers / Side Item

사무 공간을 함께 꾸밀 수 있는 공용 서랍입니다.  
It is a common drawer that can be used to organize office space.



### 이동식 서랍박스

- 일반키와 전자키 두 가지 타입이며, 사출 서랍박스의 탈부착 펜트레이는 다양한 기능으로 활용이 가능합니다.
  - 문구류 및 소품들을 효율적으로 보관할 수 있는 트레이로 구성됩니다.
  - 하부 인출장은 물품 규격에 따라 내부 선반의 높이를 조절 가능합니다.
  - 상단 1단 서랍에 소지품 보관이 용이하며 상부면과 전면에도 수납이 가능합니다.
- It comes in two types: general key and digital key, and the detachable pen tray of the injection-molded drawer box can be utilized for various functions.
  - It is composed of a tray that can efficiently store stationery and small items.
  - The lower part storage allows for adjustable shelf heights according to the dimensions of the items.
  - The top drawer is convenient for storing personal belongings, and there are storage options on both the top surface and the front.

- 내부 거울로 옷 매무새 정돈이 가능합니다.
- 옷장의 철판(옵션)에 자석을 부착할 수 있으며, 다양한 컬러로 조화롭게 구성 가능합니다.
- 멀티장의 중간 선반은 업무 면적을 확장하고 하부는 수납 활용이 가능합니다.

- There is a mirror inside to check if the outfit is properly dressed.
- Magnets can be attached to the metal sheet (optional) of the wardrobe. It can be harmoniously configured in various colors.
- The middle shelf of the multi-storage can expand the workspace area, and the lower part can be used for storage.



## Side Item

### Common Drawers 공용 서랍장

\* 전자키 별도 주문



서랍박스(2단/3단/3단확장형)  
Drawer  
(2-Level/3-Level/3-Level Extended Type)  
Color. SW / WOA / NW / SS  
404 · 500 · 604  
404 · 500 · 654(확장형)



이동서랍 2단/3단(서랍전면 사출사양)  
Movable Drawers(Injection Moulding-based Fronts)  
2/3단, 2/3단 전자키 2/3-Level, 2/3-Level Digital Key  
Color. SW  
400 · 553 · 582  
\* RF+키패드 전자키 포함 / 펜트레이 구성



하부 인출장  
Single-door Storage  
Color. SW / WOA  
413 · 648 · 655  
\* SW / WOA 한정 운영



멀티 하부장  
Multi Lower Part Storage  
Color. SW  
1100 · 350 · 622  
\* SW 한정 운영



멀티장  
Multi Cabinet  
Color. SW / WOA / UOA  
401 · 810 · 1200



옷장 일반/전자키  
Wardrobe General Key/Digital Key  
Color. SW / WOA / UOA  
200 · 795 · 1200  
\* 전자키 / 철판 별도 주문  
\* 철판 컬러 (SW / YE / TC / SBK)



책상 보조형 사이드 테이블 Side Table  
Color. SW / WOA / UOA  
1200 · 600 · 730



보조형 익스텐션 Side Extension  
Color. SW / WOA  
600 · 1200 · 730



원형 회의테이블 Round Conference Table  
Color. SW / WOA / UOA  
900 · 900 · 730



사각 회의테이블 Square Conference Table  
Color. SW / WOA  
600/1000 · 600 · 730



매립형 전자키 Digital Key  
Color. White  
슬림 지문형/ RF카드형+키패드  
Slim Fingerprint Type+Keypad

#### Color/Material



# 002 Group Cabinet



## 사용자 맞춤형 캐비닛 002G

안정적인 구조의 캐비닛은 다양한 크기의 서류의 수납이 가능합니다.  
 사용자가 원하는 높이는 물론 도어와 시건 타입을 선택할 수 있습니다.  
 Cabinet with stable structure can store documents with various sizes.  
 It may select door and siegen type, along with height a that user wants it to be.



캐비닛 5단/3단(WOA)



- 1 알루미늄 인서트형 핸들을 적용하여 고급스럽고 편리합니다.
  - 2 스무스 힌지로 도어를 닫을 때 충격을 방지합니다.
  - 3 일반 열쇠형과 전자키형 중 선택할 수 있습니다. 두가지 타입의 전자키형으로 스마트한 사용이 가능합니다.
- 1 The aluminum-inserted handle is luxurious and convenient.  
 2 Smooth hinges prevent shocks when closing the door.  
 3 There are two options : Regular Key and Electronic Key Type. Smart use is possible in two types of electronic keys.

# Cabinet

## Cabinet 캐비닛

\* 전자키를 별도로 주문하여야 합니다.  
 \* Digital key available for a separate purchase.



캐비닛(2단) Cabinet(2-Level Shelves)  
 Color. WOA / SW / UOA  
 800 · 420 · 807  
 \* 해당 이미지 컬러 UOA



캐비닛(3단) Cabinet(3-Level Shelves)  
 Color. WOA / SW / UOA  
 800 · 420 · 1160  
 \* 해당 이미지 컬러 SW



캐비닛(5단) Cabinet(5-Level Shelves)  
 Color. WOA / SW / UOA  
 800 · 420 · 1866  
 \* 해당 이미지 컬러 SW



캐비닛(6단) Cabinet(6-Level Shelves)  
 Color. WOA / SW / UOA  
 800 · 420 · 2219  
 \* 해당 이미지 컬러 WOA

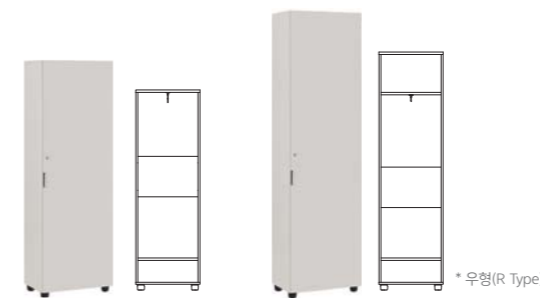

옷장 Wardrobe  
 Color. SW  
 600 · 420 · 1866(5단겸용)  
 600 · 420 · 2219(6단겸용)  
 \* 해당 이미지 컬러 SW  
 \* 인출식 옷걸이  
 \* 좌/우형 운영



화분대  
 Color. SW / WOA / UOA  
 798 · 418 · 150  
 \* 캐비닛 상부 결합(현장조립)  
 \* 하부만 목대형



## 002 Group Locker Storage Closet

변동좌석제를 적용한 오피스에서 개인의 물품을 안전하게 보관할 수 있는 락장치형 사물함입니다.  
It is a lock type locker that can safely store personal items in the office with variable seating system.



- 1 사용자가 원하는 높이를 선택해서 사용할 수 있도록 3단 이동선반을 적용하였으며, 이동선반 사용시 선반의 낙하방지를 위해 4개의 이동촉다보를 사용하여 안전합니다.
- 2 선반을 이용해서 사용하거나 이동선반 없이 넓은 공간으로도 사용이 가능합니다.
- 3 리바트 오피스 툴박스가 들어갈 수 있는 사이즈로 제작되었습니다.
- 4 외관상 노출되지 않도록 제품 안쪽으로 코너레벨러를 설치해 수평을 맞출 수 있습니다.
- 5 락 장치는 일반 열쇠형과 전자키형 중 선택이 가능합니다. 전자키형은 사용자가 직접 비밀번호를 설정하여 별도의 열쇠가 필요하지 않습니다.

- 1 A three-stage moving shelf has been applied so that the user can select and use the height desired. It is safe to use four moving tabs to prevent falling of the shelf when using the moving shelf.
- 2 It can be used as a shelf or in a large space without a moving shelf.
- 3 It is designed for the Livart Office Toolbox to fit into.
- 4 The corner leveler can be leveled inside the product to prevent it from being exposed.
- 5 The lock can be selected from the standard key type and the electronic key type. The electronic key type does not require a separate key because the user sets a password.

## Locker Storage Closet

### Locker Storage Closet 락 장치형 사물함

\* 전자키 별도 주문



1열 3단사물함 일반형  
Row 3 Steps, Locker, General Type  
Color. SW  
400 · 510 · 1865



1열 4단사물함 일반형  
Row 4 Steps, Locker, General Type  
Color. SW  
400 · 510 · 1865

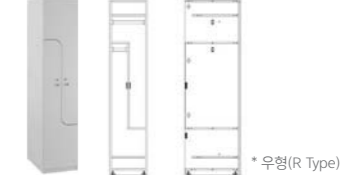

1열 옷장형 사물함 일반형 (좌/우형)  
Row 2 Steps, Wardrobe, General Type (L/R Type)  
Color. SW  
400 · 610 · 1865  
\* 봉형 옷걸이



1열 3단사물함 스마트형  
Row 3 Steps, Locker, Smart Type  
Color. SW  
400 · 510 · 1865  
\* 스마트형 전자키 별도 주문



1열 4단사물함 스마트형  
Row 4 Steps, Locker, Smart Type  
Color. SW  
400 · 510 · 1865  
\* 스마트형 전자키 별도 주문



1열 옷장형 사물함 스마트형 (좌/우형)  
Row 2 Steps, Wardrobe, Smart Type (L/R Type)  
Color. SW  
400 · 610 · 1865  
\* 스마트형 전자키 별도 주문  
\* 봉형 옷걸이



일반 옷장 와이드형  
Wardrobe, Wide Type  
Color. SW  
800 · 610 · 1865  
\* 스마트형 전자키 별도 주문  
\* 봉형 옷걸이  
\* 거울 포함



옷장 마감 패널  
Wardrobe Finish Panel  
Color. SW  
610 · 18 · 1865  
\* 2EA 1SET



매립형 전자키  
Digital Key  
Color. White / Black  
슬림형 지문+키패드형  
Slim Fingerprint + Keypad Type  
슬림형 RF카드+키패드형  
Slim RF Card + Keypad Type

Color/Material

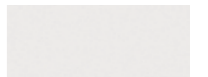

SW / LPM

# Desk Screen

다양한 컬러와 옵션을 통해 여러 가지 조합으로 공간 분리가 가능한 스크린 파티션입니다.

This is a screen partition that allows for space division in various combinations with a range of colors and options available.



- 1 스크린의 메모 보드의 마그네틱을 활용하여 간단한 서류 핀업이 가능합니다.
- 2 스크린 브라켓으로 별도의 장치 없이 수평 배선이 가능합니다.
- 3 이격형 스크린은 상판과 스크린 사이 30mm 공간 이격으로 모니터암 설치가 용이합니다.
- 4 이격형 스크린 설치 후, 후면 스페이서를 사용하면 스크린 뒤쪽에 30mm의 이격 공간을 쉽게 확보할 수 있습니다.

- 1 The memo board on the screen utilizes a magnetic feature that allows for easy pinning of simple documents.
- 2 The screen bracket enables horizontal wiring without the need for additional devices.
- 3 The design of the spaced screen facilitates the installation of monitor arms by incorporating a 30mm gap between the top panel and the screen.
- 4 After installing the spaced screen, using a rear spacer can easily secure a 30mm gap behind the screen.

## 세부 규격 Specification

일반 스크린 General Screen

높은 스크린 High Screen

펠트 스크린 Felt Screen

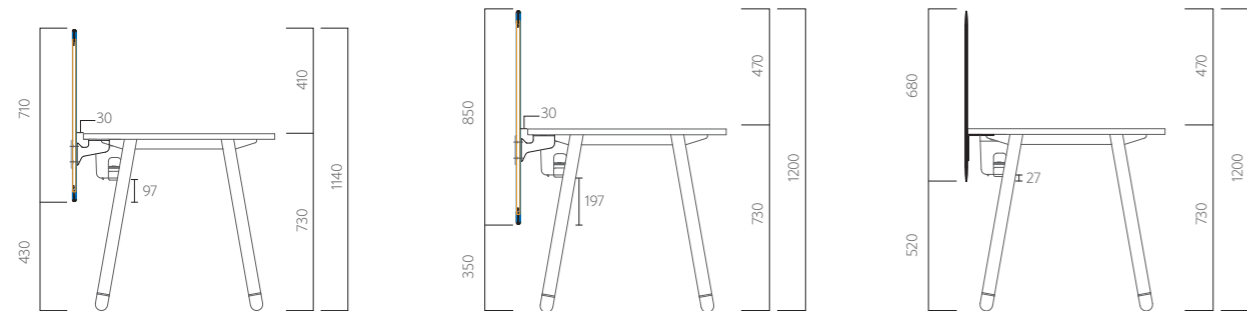

구분	패브릭 스크린		이격형 스크린		펠트 스크린
	일반형	높은형	일반형	높은형	일반형
Easy Linker	410	470	410	470	470
Easy Linker Motion	410	470	410	470	470
Lite Space	410	470	410	470	470
비고	* Easy Linker W600 한정 HW50020SP 사용		* 모니터암 설치용 EASY LINKER 제품 한정		* 브라켓 : 일반형 운영

# Desk Screen

## Desk Screen(Fabric) 데스크 스크린(패브릭)

**전면 일반 스크린 Front General Type**  
Color. BU / GN / GY / RE

598/1098/1198/1398/1598/1798 · 12 · 710  
\* EASY LINKER, LITE SPACE, Motion Desk 제품 한정  
\* 책상 위 노출 높이 H410 / 책상 아래 노출 높이 H430  
\* BE 출시 예정

**전면 높은 스크린 Front High Type**  
Color. BU / GN / GY / RE

598/1098/1198/1398/1598/1798 · 12 · 850  
\* EASY LINKER, LITE SPACE, Motion Desk 제품 한정  
\* 책상 위 노출 높이 H470 / 책상 아래 노출 높이 H350  
\* BE 출시 예정

**측면 일반/높은 스크린 Side General/High Type**  
Color. BU / GN / GY / RE

788 · 12 · 710 / 850  
EASY LINKER / MOTION DESK / LITE SPACE  
\* BE 출시 예정

**이격형 측면 스크린 Spaced Side Screen**  
Color. BU / GN / GY / RE

818 · 12 · 710/850  
\* 모니터암 설치용 EASY LINKER 제품 한정  
\* BE 출시 예정

**이격형 스크린 Spaced Screen**  
Color. BU / GN / GY / RE

1098/1198/1398/1598/1798 · 12 · 710/850  
\* 모니터암 설치용 EASY LINKER 제품 한정  
\* BE 출시 예정

**이격형 후면 스페이서 Spaced Back Spacer**  
Color. SW

138 · 26 · 25

**일자형 코너 철재스크린 Linear-corner Steel Screen**  
Color. SW

281 · 32 · 435/495  
\*일반형/ 이격형 2 Type

**삼각형 코너 철재스크린 Triangle-corner Steel Screen**  
Color. SW

281 · 234 · 435/495  
\*일반형/ 이격형 2 Type

**브라켓 후면 마감캡 Bracket Back Cover**

24 · 88 · 13  
\* SHW50030SP 제외 사용가능

**Color/Material**

GY / FABRIC      BE / FABRIC  
\* 출시 예정

## Desk Screen(Felt) 데스크 스크린(펠트)

**전면 스크린(일반형) Front Screen(General Type)**  
Color. NV / DG / BE / LG

1200 / 1400 / 1600 / 1800 · 10T · 680

**측면 스크린(일반형) Side Screen(General Type)**  
Color. NV / DG / BE / LG

600 / 795 · 10T · 680

**Color/Material**

NV / FELT      DG / FELT      BE / FELT      LG / FELT

# Accessories

Various office furniture and equipment according to user needs

## 사용자에 따른 다양한 오피스 아이템

다양하게 변화되어 가고 있는 오피스 환경 속에서 리바트만의 세심한 아이디어로 탄생한 효율적인 오피스 아이템입니다.  
It is an efficient office furniture created with the LIVART's own thoughtful ideas for office environment continuing to change.



## 툴박스 Toolbox



- 1 내부 수납함은 A4 결재서류를 수납할 수 있으며, 내부 깊이 17mm의 펜트레이로 필기구류를 이탈없이 수납 가능합니다. 툴박스 덮개를 열면 내부에 명함을 꽂을 수 있습니다.
- 2 노트북 거치대는 외부 커버를 열고 각도조절 다리를 활용해 알맞은 각도와 높이를 조정하여, 외부커버를 열어 사용할 수 있습니다.
- 1 The internal storage compartment can accommodate A4-size documents, and a 17mm deep pen tray allows for secure storage of writing instruments without displacement. Upon opening the toolbox cover, there is a slot for business cards inside.
- 2 Laptop tilt stand open the external cover and set proper angle and height using the angle adjustment leg.

## 추가 액세서리 Additional Accessories



- 1 선반 측면 그레이 컬러의 클립을 슬라이드 방식으로 밀어주면 다릿발의 높이를 조절할 수 있습니다. 작업환경에 적합한 높이에 맞춰 총 4단계로 높이 조절이 가능합니다.
- 2 핸드폰을 무선으로 충전할 수 있도록 모니터 선반 좌/우 원하는 위치에 조립 설치가 가능하며, 모니터선반 상판에는 무선충전기의 위치를 알려주는 음각표시가 되어있습니다. (옵션 품목)
- 3 사용자의 편리함을 위해 모니터 선반 좌/우 원하는 위치에 3구 USB 포트 추가가 가능합니다. (옵션 품목)
- 4 회전형 트레이로 깔끔한 필기구 정리가 가능합니다. (상판 체결 필수)

- 1 You can adjust the height of the legs by sliding the gray colored clip on the side of the shelf. The height can be adjusted in 4 steps according to the height suitable for the working environment.
- 2 It is possible to assemble and install on the left/right of the monitor shelf so that you can wirelessly charge your mobile phone, and the top of the monitor shelf is marked with an intaglio indicating the location of the wireless charger. (Optional item)
- 3 For user convenience, it is possible to add a 3-prong USB port on the left/right side of the monitor shelf. (Optional item)
- 4 Rotating shelves allows neat organization of stationeries. (Top board must be attached)



## Accessory Item



- 1 철제 다릿발에 부착하여 케이블의 늘어짐 방지는 물론 형태 구분 없이 원하는 위치에 사용이 가능합니다.
  - 2 순방향 사각 컬럼에 부착 가능하며, 자석 스틸 커버로 탈부착 기능과 깔끔한 디자인을 선사합니다. (네오디움자석 4EA 포함)
  - 3 3가지 색상 운영으로 책상에 어울리는 색상을 선택하실 수 있습니다. (LIVART 로고 음각 표기)
- 1 Attached to the metal legs, this prevents the cable from stretching and can be used at any desired position without regard to form.
  - 2 It can be attached to the forward-facing square column and features a magnetic steel cover that allows for easy attachment and detachment, providing a neat design. (Includes 4 neodymium magnets)
  - 3 Available in three colors, allowing for the selection of a color that matches the desk. (Features a debossed LIVART logo)

### Accessory Item



콤보 책꽂이  
Combo Bookshelf  
287 · 209 · 210



데스크탑 홀더  
Desktop Holder  
279 · 180 · 174



하이브 데스크 오거나이즈  
Hive Desk Organizer  
180 · 138 · 237



홀더 트레이  
Holder Tray  
287 · 105 · 96



월 포켓(대) Wall Pocket(L)  
292 · 82 · 90



월 포켓(소) Wall Pocket(S)  
114 · 75 · 152



북스탠디 Book Standy  
Color. White, Beige  
229 · 200 · 182



펜트레이 Pen Tray  
Color. White, Beige  
205 · 86 · 101



슬림 오거나이저 Slim Organizer  
Color. White, Beige  
280 · 55 · 60



모니터선반  
Monitor Base  
일반형 General Type 527 · 260 · 100  
연결형 Extend Type 389 · 260 · 100



모니터선반 무선충전  
Wireless Charger for Monitor Base  
\*충전선 포함, 어댑터 불포함



모니터 받침대  
Monitor Base  
800 · 310 · 180



케이블 기본타입(H750)  
Cable Management General Type(H750)  
Color. GY / SW / SBK  
110 · 130 · 759  
\* 회의테이블용



케이블 기본타입(H1300)  
Cable Management General Type(H1300)  
Color. GY / SW / SBK  
110 · 130 · 1310  
\* 데스크용



순방향 사각 컬럼용  
For Forward Square Columns Type  
Color. SW / SBK  
34 · 50 · 1282  
\* 정방향 컬럼에 적용 가능  
(오피스 이지링커 모션데스크 매칭 가능)



원형 컬럼용  
For Circular Columns Type  
Color. SW  
68 · 72 · 1283  
\* 원형 컬럼에 적용 가능



회전형 트레이  
Rotary Tray  
180 · 320 · 44



휴대폰 거치대 (독립형/거치형)  
Mobile Base (Independent Type/  
Connecting Type)  
독립형 Independent Type  
100 · 171 · 133  
거치형 Connecting Type  
90 · 84 · 108  
\* 오더메이드, 충전선 포함, 어댑터 불포함



툴박스  
Tool Box  
370 · 277 · 64



싱글 모니터암  
Single Monitor Arm  
\* 적용 베사 사이즈 : 75/100  
(VESA Compliant 75x75mm/100x100mm)  
\* 상하 높이 200~530mm  
\* 앞뒤 거리 60~550mm



듀얼 모니터암  
Dual Monitor Arm  
\* 적용 베사 사이즈 : 75/100  
(VESA Compliant 75x75mm/100x100mm)  
\* 상하 높이 200~530mm  
\* 앞뒤 거리 60~550mm



PC 홀더(브라켓형/일반형)  
PC Mount  
(Bracket-type/Normal-type)  
Color. Black  
\* 거치가능 높이 : 300~510 mm /  
거치 가능 넓이 : 88~203 mm  
\* 회전 가능 각도 : 180도

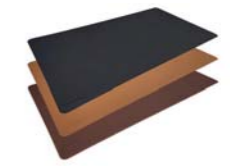

데스크 패드  
Desk Pad  
Color. BK / DB / LB  
800 · 400 · 2



전선정리용 클립 / 가방걸이  
Bag Hanger /  
Clip for wiring, wired screen  
Color. SW  
\*6ea = 1set, 스크린 클립 브라켓 대체 사용  
\*6ea = 1set, clip bracket for screen can be used as an alternative



2구 2USB 타입 추가 전원  
2-outlet, 2-USB Type  
Additional Power  
스탠드형 Stand Type  
클램프형 Clamp Type  
하부거치형 Under-mount Type

# 30T Partition 30T 파티션



Economical partition in simple and concise style

## 심플하고 간결한 스타일의 경제적인 파티션

더욱 슬림한 파티션으로 공간이 시원스럽게 보이며, 업무영역 및 개인 업무 보호로 기존 파티션보다 효과적인 커뮤니케이션 환경을 제공합니다. 30T 파티션은 오피스 제품인 C600그룹과 연계하여 사용이 가능하도록 디자인하였습니다.

The slimmer partition makes the space look cooler and the work area and personal work protection provide more effective communication environment than the existing partition. The 30T partition was designed to be assembled with the office C600 group.



- 1 코너 라운드형 파티션 Corner Round Partition  
라운드 곡선형을 적용하여 부드러운 오피스 분위기를 연출해줍니다.
- 2 코너 90도형 단면/분할 파티션 Corner 90-Degree Section / Division Partition  
코너를 직선으로 구성하여 간결하면서도 모던한 분위기의 오피스를 만들어줍니다.
- 3 30T 라운드파티션 (90도, 120도) 30T Round Partition (90 Degrees, 120 Degrees)  
코너에 라운드 형상을 지닌 심플하고 간결한 스타일의 파티션으로 레이아웃 배치 시 90도와 120도로 형상화 할 수 있습니다. 미팅공간, 개인공간, 집중업무공간 등으로 구성 가능합니다.

- 1 Apply round curves to create a soft office feel.
- 2 Creates a simple, modern office with straight corners. Wire passing type, split type, upper magnet type, stacking partition.
- 3 A simple and clean partition which is curved at its corner. It can be configured as 90-degree or 120-degree, and also be configured to create a space for meeting, personal use and concentrated work.

## 30T Partition

H : 1050mm

\* 주문시, 영업 비고란 패브릭 마감재 지정 필수



일반형 General Type

Color. LGY / MGY / DGY / LBU / LBR / LGN / OR

600/700/800/1000/1200/1400/1600/1800 · 30



분할형 Split Type

Color. LGY / MGY / DGY / LBU / LBR / LGN / OR

600/700/800/1000/1200/1400/1600/1800 · 30



분할형/상부자석형 Split Type/Upper Magnet Type

Color. LGY / MGY / DGY / LBU / LBR / LGN / OR

600/700/800/1000/1200/1400/1600/1800 · 30



코너라운드형

Corner Round Type

Color. LGY / MGY / DGY / LBU / LBR / LGN / OR

600/700/800/1000/1200/1400/1600/1800 · 30



코너라운드형/분할형

Corner Round Type/Split Type

Color. LGY / MGY / DGY / LBU / LBR / LGN / OR

600/700/800/1000/1200/1400/1600/1800 · 30



코너라운드형/분할형/자석형

Corner Round Type/  
Split Type/Upper Magnet Type

Color. LGY / MGY / DGY / LBU / LBR / LGN / OR

600/700/800/1000/1200/1400/1600/1800 · 30

## 30T Partition

H : 1200mm

\* 주문시, 영업 비고란 패브릭 마감재 지정 필수



일반형 General Type

Color. LGY / MGY / DGY / LBU / LBR / LGN / OR

600/700/800/1000/1200/1400/1600/1800 · 30



분할형 Split Type

Color. LGY / MGY / DGY / LBU / LBR / LGN / OR

600/700/800/1000/1200/1400/1600/1800 · 30



분할형/상부자석형 Split Type/Upper Magnet Type

Color. LGY / MGY / DGY / LBU / LBR / LGN / OR

600/700/800/1000/1200/1400/1600/1800 · 30



코너라운드형

Corner Round Type

Color. LGY / MGY / DGY / LBU / LBR / LGN / OR

600/700/800/1000/1200/1400/1600/1800 · 30



코너라운드형/분할형/자석형

Corner Round Type/  
Split Type/Upper Magnet Type

Color. LGY / MGY / DGY / LBU / LBR / LGN / OR

600/700/800/1000/1200/1400/1600/1800 · 30



코너라운드형/분할형

Corner Round Type/Split Type

Color. LGY / MGY / DGY / LBU / LBR / LGN / OR

600/700/800/1000/1200/1400/1600/1800 · 30

Color



PF62 / LIGHT GRAY

PF63 / MEDIUM GRAY

PF64 / DARK GRAY

PF65 / LIGHT BLUE

PF66 / LIGHT BROWN

PF68 / LIGHT GREEN

PF69 / ORANGE

## 30T Partition

### H : 1500mm

\* 주문시, 영업 비교란 패브릭 마감재 지정 필수



**일반형 General Type**  
Color. LGY / MGY / DGY / LBU / LBR / LGN / OR  
600/700/800/1000/1200 · 30



**분할형 Split Type**  
Color. LGY / MGY / DGY / LBU / LBR / LGN / OR  
600/700/800/1000/1200/1400/1600/1800 · 30



**분할형/상부자석형 Split Type/Upper Magnet Type**  
Color. LGY / MGY / DGY / LBU / LBR / LGN / OR  
600/700/800/1000/1200/1400/1600/1800 · 30



**코너라운드형 Corner Round Type**  
Color. LGY / MGY / DGY / LBU / LBR / LGN / OR  
600/700/800/1000/1200 · 30



**코너라운드형/분할형 Corner Round Type/Split Type**  
Color. LGY / MGY / DGY / LBU / LBR / LGN / OR  
600/700/800/1000/1200/1400/1600/1800 · 30



**코너라운드형/분할형/자석형 Corner Round Type/Split Type/Upper Magnet Type**  
Color. LGY / MGY / DGY / LBU / LBR / LGN / OR  
600/700/800/1000/1200/1400/1600/1800 · 30

### H : 1350mm

\* 주문시, 영업 비교란 패브릭 마감재 지정 필수



**코너라운드형 Corner Round Type**  
Color. LGY / MGY / DGY / LBU / LBR / LGN / OR  
600/700/800/1000/1200 · 30



**90도형 90-Degree Type**  
Color. LGY / MGY / DGY / LBU / LBR / LGN / OR  
450 · 450 · 1350/1500



**120도형 120-Degree Type**  
Color. LGY / MGY / DGY / LBU / LBR / LGN / OR  
775 · 1350/1500

#### Color



## 30T Partition

### 파티션 보조물 Partition Support



**포스트 일반형 Post General Type**  
**포스트 코너라운드형 Post Corner Round Type**

L형 L-configuration  
T형 T-configuration  
X형 X-configuration

H1050 / H1200 / H1500



**마감바 일반형 Post General Type**  
**포스트 코너라운드형 Post Corner Round Type**

L형 L-configuration  
T형 T-configuration  
X형 X-configuration

H1050 / H1200 / H1500



**안정각 Stabilizer**

### 액세서리 Accessories



**선반 Shelf**

350 · 137 · 235



**가로형 옷걸이 Horizontal Hook Hanger**

Color. Gray / Ivory / Red

400 · 130 · 34  
\* 옷걸이 주문시 옷걸이걸러  
가로형 (3EA), 세로형(2EA) 주문 필수



**세로형 옷걸이 Vertical Hook Hanger**

Color. Gray / Ivory / Red

60 · 260 · 34  
\* 옷걸이 주문시 옷걸이걸러  
가로형 (3EA), 세로형(2EA) 주문 필수

# Office Executive

## VENEER



RESERVA 70



EX9 900 Group 74

## LAMINATE



CUERNO 80



Office-One 86



MONTER 96



MOTION DESK 102

# RESERVA 리제르바

The new Heritage series defined by refined design lines and a combination of premium materials

고급화된 라인의 디자인, 프리미엄 소재들의 조합으로 새로운 헤리티지 시리즈

부드럽고 섬세한 디자인과 차별화된 기술력을 담아 특별한 중역 공간을 제공합니다.

자연의 곡선과 따뜻한 색감으로 편안하고 우아하며, 제품 배치만으로도 인테리어가 되는 프리미엄 시리즈입니다.

Featuring soft and intricate designs and advanced technology, this series provides a distinguished executive space. Its natural curves and warm tones offer comfort and elegance, while the arrangement of the products themselves enhances the interior, making it a premium series.



# RESERVA

남프랑스 모젤강의 경관을 담은 디자인은 희소한 포인트와 독창적인 아름다움을 더해줍니다. 고급 원목의 자연스러운 결을 살려 따뜻하면서도 세련된 감성을 더하고, 감각적인 디자인과 공학적인 설계를 결합하여 사용자의 창의성을 극대화해줍니다.

The design, inspired by the scenery of the Moselle River in southern France, adds rare points and unique beauty. By highlighting the natural grain of high-quality wood, it brings a warm yet sophisticated sensibility. The combination of a sensuous design and engineering principles maximizes the user's creativity.



## 01. 차별화된 디자인 Unique Design

책상의 부드러운 곡선과 섬세한 디테일, 완벽한 균형의 3다리 설계로 세련된 감성과 창의성을 제공합니다. The soft curves and delicate details of the desk, along with the perfectly balanced three-leg design, offer a sophisticated sensibility and creativity.



## 02. 유선형 하부 스크린 Curved Lower Screen

책상의 곡선을 담은 유선형 하부 스크린은 브라운 톤과 섬세한 스티치로 고급스럽고 우아한 공간을 연출합니다. The curved, streamlined lower screen of the desk captures elegance with its brown tones and delicate stitching, creating a luxurious and sophisticated space.

## 03. 아트월 구성 Art Wall Design

아트월은 캐비닛 사이를 연결하고, 우드와 브론즈 유리의 고급스러운 조합으로 공간의 깊이감을 더합니다. The three art walls connect between the cabinets, enhancing the depth of the space with a luxurious combination of wood and bronze glass. This design element adds both visual interest and sophistication to the overall environment.

## 04. 오브제형 하부 서랍장 Object-Style Lower Cabinet

오브제같은 서랍장은 보조 상판 역할과 수납력을 더해 감각적이고 실용적인 공간을 만들어줍니다. The drawer unit, resembling an object, adds both a secondary tabletop function and storage capacity,

# RESERVA



**원목 책상**  
wood desk  
Color. ASH / LW  
2240 · 1120 · 745  
\* 원목 / LPM 운영 \* 원목 사양 : 오더메이드



**하부장**  
Lower Part Storage  
Color. CM  
1225 · 620 · 600



**W2400 원형회의테이블**  
W2400 Round Conference Table  
Color. WOOD+CM  
Ø2400 · H750



**원형 테이블 Round Table**  
Color. WOOD+CM  
Ø1200 · H750



**아트월 Art Wall**  
Color. Natural Ash  
600 · 137 · 1935



**유리 선반 Glass Shelf**  
Color. Glass  
656 · 204 · 8  
\* 선반 4EA 포함



**라운드 엔드 패널 (소) Round End Panel (Small)**  
Color. CM / CRM  
400 · 120 · 1935  
\* 좌/우형 운영



**라운드 엔드 패널 (대) Round End Panel (Large)**  
Color. CM / CRM  
400 · 200 · 1935  
\* 좌/우형 운영



**리제르바 책장 Reserba Bookcase**  
Color. CRM  
800 · 400 · 1935



**리제르바 옷장 Reserba Wardrobe**  
일반키/전자키 General Key/Digital Key  
Color. CM  
600 · 400 · 1935

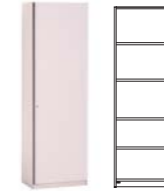

**책장**  
Bookcase  
Color. LBE  
600 · 400 · 1935



**옷장 Wardrobe**  
일반키/전자키 General Key/Digital Key  
Color. LBE  
600 · 400 · 1935



**상하부 책장 Four-Door Bookcase**  
Color. LBE  
800 · 400 · 1935



**은경 책장 Mirror Door Bookcase**  
Color. LBE  
800 · 400 · 1935



**측면 마감 패널 Side End Panel**  
Color. LBE  
400 · 1935 · T18  
\* 2개 1세트 (2EA 1SET)

**Color/Material**

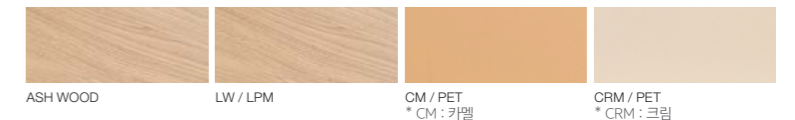

ASH WOOD

LW / LPM

CM / PET  
\* CM : 카멜

CRM / PET  
\* CRM : 크림

# EX9 900 Group



The highest class fumigation veneer with luxurious and modern design provides new environment

최고급 훈증무늬목의 고급스러움과 모던한 디자인이 선사하는 새로운 감각

트렌디하면서도 볼륨감 넘치고, 고급스러우면서도 모던한 새로운 감각의 EX9.

기품있는 디자인에 사용 편의성 또한 갖춘 중역용 오피스 가구입니다.

EX9 with trendy, glamorous, luxurious and modern design.

Executive office furniture possessing elegant design and utility.



## EX9 900 Group

최고급 훈증무늬목이 사용된 책상과 회의테이블, 크레덴자, 장식장, 옷장 등이 일체감있게 구성되어 기품있고 조화로운 중역 공간을 연출합니다.

The highest class fumigation veneer desk, conference table, credenza, wardrobe provides consistency and harmonious executive work space.



### 01. Bachmann사 덕트 적용 Bachmann Company Duct Application

무늬목으로 마감한 덕트커버와 Bachmann사의 전선덕트를 사용하여 군더더기 없는 디자인과 기능성을 모두 잡았습니다.

Veneer finishing duct cover and Bachmann's wire ducts provide clean design and utility.



### 02. 넉넉한 수납의 하부장 Lower Storage with Various Storage

PC장, 서랍장, 다용도 수납공간까지 넉넉하게 갖추었으며, 댄핑기능이 적용된 서랍, 슬라이딩 도어, 푸쉬도어로 부드러운 사용감을 제공하는 하부장

Lower cabinet including PC storage, cabinet, multi-use storage provides soft closing with damping function.



### 03. 스마트 보안 전자키 Smart Security Key

하부장부터 캐비닛까지 지문인식 전자키 사용으로 사용자의 중요 문서 및 귀중품 등을 안전하게 보관해줍니다. 또한 개인 신용카드 및 사원증으로도 인식이 가능한 RF인식기능이 탑재되었습니다.

Fingerprint recognition electronic keys used in lower cabinets as well as cabinets enables users to safely store important documents and valuables. It is also equipped with the RF recognition function that can be recognized by personal credit cards and employee ID cards.



### 04. 후면 수납 공간 Rear Storage Space

서랍박스 후면의 푸쉬도어를 사용하여 숨겨진 수납공간을 활용할 수 있습니다. Drawer provides hidden space with push door.



### 01. 일체감 있는 시리즈 구성 Cohesive Series Composition

최고급 훈증 무늬목을 사용하여 책상과 일체감 있게 구성된 회의테이블입니다. Conference table with the highest class fumigation veneer.



### 02. 다양한 스타일의 다릿발 Legs in Various Styles

최고급 건식무늬목에 블랙 캐스팅 다릿발을 적용한 회의 테이블입니다. Conference table with black steel leg and the highest class dry veneer.



### 03. 시리즈 맞춤 공용장 Series-Customized Common Storage

캐비닛류 또한 콤비 모델로 조합 가능하여 전체적인 룬의 통일성을 유지합니다. The cabinet types can also be combined into a combi model, maintaining the overall uniformity of the room.

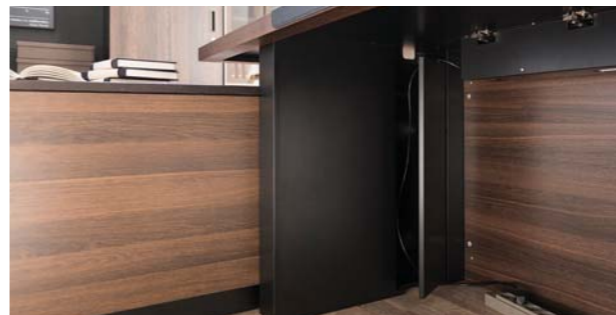

### 04. 다릿발 활용 배선 정리 Wiring Organization using Leg Supports

책상 다리 내부공간을 활용하여 전선 및 각종 케이블, 외부 전자기기 케이블 등을 효과적으로 정리할 수 있습니다. Efficient arrangement use with inner space of table.



### 05. 고급스럽고 모던한 디자인 Luxurious and Modern Design

최고급 건식 훈증무늬목을 사용하여 압도적인 밸류감과 컬러감을 선사합니다. The highest class dry veneer provides overwhelming value and color. \* 독일 Mehlings&Weismann (SOA) & 벨기에 Decospan (AOA) \* Germany Mehlings & Weismann's (SOA) & Belgium Decospan's (AOA)

# Space Planning

## EX9 900 Group - ALT1

### Floor Plan

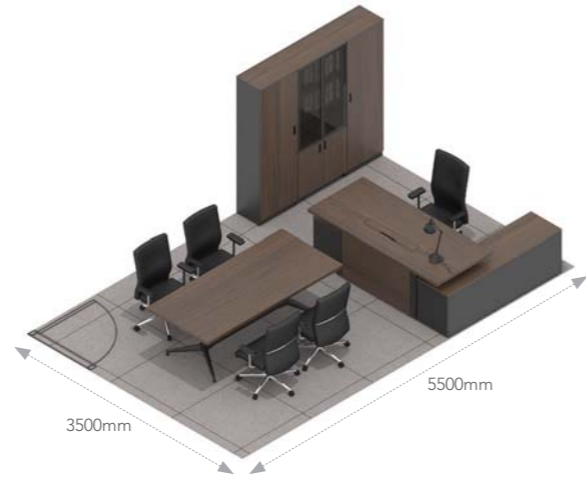

### Desk Zone



### Meeting Zone



## EX9 900 Group - ALT2

### Floor Plan

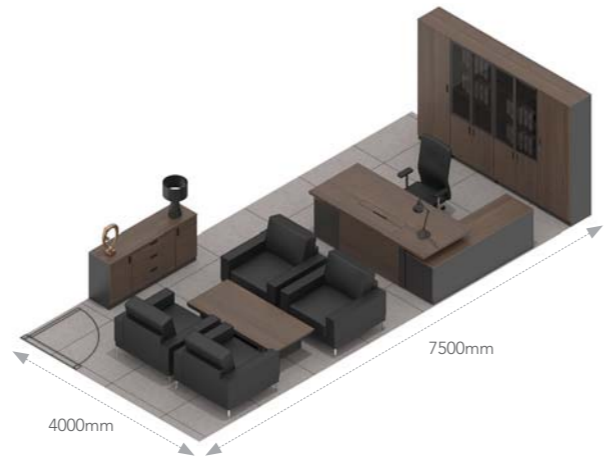

### Desk Zone



### Meeting Zone



# EX9 900 Group

\* 중역 키 세트 별도 주문 가능 (코드 별책 참고)



**데스크 Desk**  
Color : SOA(V901) / AOA(V902)  
2100 · 900 · 750  
\* 덕트사양 : 3구 2벤포트+2USB  
\* 데스크패드 옵션 (800 · 515 · 50)



**EX9 전동식 양수 책상 EX9 Electric Lift Desk**  
Color: SOA / AOA  
2100 · 900 · 723-1223



**EX9 전동 사이드 책상 EX9 Electric Side Desk**  
Color: SOA / AOA  
1200 · 590 · 723-1223



**3단 서랍 3-Level Drawer**  
일반키/전자키 General Key/Digital Key  
Color: SOA(L901) / AOA(L902)  
398 · 776 · 602  
\* 전자키 포함 / 실린더 1EA  
\* 좌형(L) : 후면 좌도어 / 우형(R) : 후면 우도어



**하부장 Lower Part Storage**  
일반키/전자키 General Key/Digital Key  
Color: SOA(L901) / AOA(L902)  
1860 · 500 · 602  
\* 전자키 포함 / 실린더 1EA



**크레덴자 Credenza**  
Color: SOA(L901) / AOA(L902)  
1600 · 400 · 738



**회의용 테이블 (목재형) Conference Table**  
Color: SOA(V901) / AOA(V902)  
2200 · 1000 · 750  
\* 회의테이블간 상판 호환 불가



**회의용 테이블 (스틸형) Conference Table**  
Color: SOA(V901) / AOA(V902)  
2200 · 1000 · 720  
\* 회의테이블간 상판 호환 불가



**원형 테이블 Round Table**  
Color: SOA(V901) / AOA(V902) +BK  
Ø1200 · H740



**차탁자 / 협탁 Tea Table / Side Table**  
Color: SOA(V901) / SOA(L901) / AOA(V902) / AOA(L901)  
1600 · 750 · 420 / 418 · 700 · 505

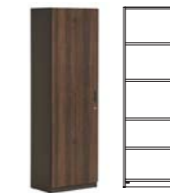

**책장 Bookcase**  
Color: SOA(L901) / AOA(L902)  
600 · 400 · 1935



**옷장 Wardrobe**  
일반키/전자키 General Key/Digital Key  
Color: SOA(L901) / AOA(L902)  
600 · 400 · 1935  
\* 지문+RF 전자키



**상하부 책장 Four-Door Bookcase**  
Color: SOA(L901) / AOA(L902)  
800 · 400 · 1935



**은경 책장 Mirror Door Bookcase**  
Color: SOA(L901) / AOA(L902)  
800 · 400 · 1935



**측면 마감 패널 Side End Panel**  
Color: SOA(L901) / AOA(L902)  
400 · 1935 · T18  
\* 2개 세트 (2EA 1SET)

Color/Material



# CUERNO 쿠에르노



A sophisticated design featuring a harmony of camel-colored leather and steel

카멜 색상의 가죽과 스틸의 조화로 세련된 디자인

활발한 커뮤니케이션을 유도하는 임원 모션데스크, 색다른 컬러감과 마감으로 트렌디한 소통형 리더를 위한 시리즈입니다.

An executive motion desk that facilitates active communication, this series is designed for the trendy, communicative leader with its unique colors and finishes.



데스크, 스크린, 책장 장식장, 옷장 장식장, 크레덴서  
현대 1&C 인테리어 마감재 사용

# CUERNO

카멜 색상과 블랙의 조화로 세련된 느낌을 주고, 카멜 색상의 포인트로 일체감있게 구성되어 트렌디한 중역 공간을 연출합니다.

The harmonious blend of camel and black hues gives a sophisticated feel, and the camel accents create a cohesive and trendy executive space.



## 01. 높이 조절 데스크 Height-Adjustable Desk

700~1200mm의 자유로운 높이 조절이 가능한 데스크를 통해 자유로운 업무 공간을 만들어주며, 소통과 공감을 위한 차세대 리더의 공간을 제공합니다.  
The desk allows for free height adjustment from 700 to 1200mm, creating a flexible workspace and providing an environment for the next generation of leaders who value communication and empathy.



## 02. 4단계 메모리 스위치 4-Step Memory Switch

직관적인 높이 조절 스위치로 4단계 메모리 저장이 가능합니다.  
Features an intuitive height adjustment switch with four memory presets.



## 03. 헤링본 패브릭 스크린 Herringbone Fabric Screen

전면 스크린에는 브라운과 베이지로 톤온톤 매치된 헤링본 패턴의 패브릭이 적용되어 은은하면서 부드러운 질감을 선사합니다.  
The front screen features a herringbone pattern in brown and beige tones, offering a subtle and soft texture.



## 04. 소통형 상판 디자인 Interactive Tabletop Design

날개형 디자인으로 협업 및 미팅 공간을 제공하며, HPM 소재로 내구성과 고급스러운 질감을 제공합니다.  
While the HPM material offers durability and a luxurious texture.



## 01. 프리미엄 다릿발 Premium Legs

컬럼 박스는 카멜 색상의 인조 가죽과 무광 소프트 블랙 스틸 조합으로 고급스럽고 견고한 디테일을 선사합니다.  
The column box features a combination of camel-colored synthetic leather and matte soft black steel, providing sophisticated and durable details.



## 02. 히든 손잡이 수납장 Hidden Cabinet Handle

라운드 형의 측면 히든 손잡이를 통해 깔끔한 전면으로 디자인의 완성도를 높였습니다.  
The design's completeness is enhanced with a round, hidden side handle that allows for a clean front.



## 03. 이격형 스크린 Offset Screen

스크린과 상판이 이격되어 있어 모니터암 설치가 용이하고, 연결 부위가 숨겨져 깔끔합니다.  
The screen and top panel are spaced apart, facilitating the installation of monitor arms and hiding the connections for a neat appearance.



## 04. 플랩 도어 캐비닛 Flap-Door Cabinet

플랩 힌지를 적용하여, 안전하고 부드러운 사용감을 경험할 수 있습니다.  
Equipped with flap hinges, it offers a safe and smooth user experience.



## 05. 편리한 옷장 옵션 Convenient Closet Options

옷장 도어의 거울을 통한 정돈과, 액세서리 걸이를 사용하여 소품 보관이 편리합니다. (옷걸이봉 변경)  
The wardrobe door features a mirror for adjusting your appearance, and the accessory hooks allow for convenient storage of small items. (Clothes rod modified)



## 06. 효율적인 수납 구성 Efficient Storage System

책장과 옷장을 함께 배치하여 효율적인 수납이 가능합니다.  
Efficient storage is achieved by placing bookshelves and wardrobes together.

# Space Planning

## CUERNO - ALT1

### Floor Plan



### Desk Zone



### Meeting Zone



## CUERNO - ALT2

### Floor Plan



### Desk Zone



### Meeting Zone



# CUERNO

\* 중역 키 세트 별도 주문 가능 (코드 별책 참고)



서랍형 높낮이 책상 Drawer Height Desk  
Color . CM  
2100 · 934 · 700~1200



전면 스크린 Front Screen  
Color. HBR+HBE  
1308 · 390 · 17  
\* 좌우 공용 제품



크레덴자 Credenza  
Color. LBE+CM  
1800 · 400 · 860



원형 테이블 Round Table  
Color . LBE+CM  
Ø1200 · H742



회의테이블 Conference Table  
Color . LBE+CM  
2400 · 1200 · 742



책장 장식장 Bookcase Display Cabinet  
Color. LBE+CM  
1200 · 400 · 1935



옷장 장식장  
Closet Display Cabin  
Color. LBE+CM  
1200 · 400 · 1935



책장  
Bookcase  
Color. LBE  
600 · 400 · 1935

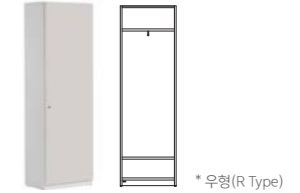

옷장 Wardrobe  
일반키/전자키 General Key/Digital Key  
Color. LBE  
600 · 400 · 1935



상하부 책장 Four-Door Bookcase  
Color. LBE  
800 · 400 · 1935

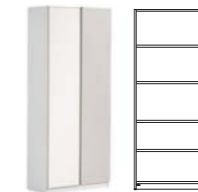

은경 책장 Mirror Door Bookcase  
Color. LBE  
800 · 400 · 1935



측면 마감 패널 Side End Panel  
Color. LBE  
400 · 1935 · T18  
\* 2개 세트 (2EA 1SET)

### Color/Material

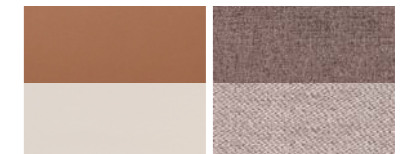

CM / LEATHER	HBR / FABRIC
LBE / HPM	HBE / FABRIC
* LBE : 라이트 베이지	* HBR : 헤링본 브라운
	* HBE : 헤링본 베이지

# Office-One 오피스원



Trendy space for leaders who communicate

트렌드를 읽고 빠르게 변화하는 문화를 수용하는 리더를 필요로 하면서 소통이 강조되는 기업문화가 정착하고 있습니다.

이를 지원해주는 공간의 역할로 부드럽고 편안한 분위기로 소통하는 리더의 공간 - 화이트&오크 콤비와

차분하게 경청하는 리더의 공간 - 다크그레이&월넛 콤비를 제안합니다.

A corporate culture that emphasizes communication and needs leaders who can read trends and mbrace a rapidly changing culture is in place. As the space to supports this environment, we ropose white & oak combination - a space for leaders who communicate in a soft and comfortable tmosphere, or a dark gray & walnut combination - a space for leaders who listen calmly and carefully.



## Office-One



### 01. 일체형 목재 덕트 Integrated Wooden Duct

상판과 동일한 목재 덕트로 일체감을 줍니다. (5구 1LAN)  
The top panel features a wood duct that matches the material, providing a unified look. (5 outlets, 1 LAN)



### 02. 심플한 수납 서랍 Simple Storage Drawers

심플한 타입의 서랍박스를 통해 가벼운 느낌의 임원실 분위기를 만들어줍니다.  
A simple type of drawer box creates a light atmosphere in the executive room.



### 03. 슬라이딩 하부장 Sliding Lower Cabinet

서랍과 슬라이딩 도어가 달린 하부장을 통해 공간을 더욱 넓게 사용할 수 있습니다.  
The space can be utilized more extensively with a lower cabinet that includes drawers and sliding doors.



### 04. 시리즈 맞춤 공용장 Series-Customized Common Storage

데스크와 콤비 조합이 가능한 캐비닛을 통하여 중역룸을 완성합니다.  
A cabinet that can be combined with the desk completes the executive room.

기존의 중후하고 무게감 있는 중역용 제품과 달리, 4LEG 타입의 데스크를 통해 가볍고 세련된 디자인을 구현할 수 있습니다. 밝고 경쾌한 컬러부터 어둡고 중후한 컬러까지 다양한 색상 옵션을 제공하며, 사이드 수납장 타입부터 대형 불박이장형 타입까지 다양한 구성으로 공간과 분위기에 맞춘 연출이 가능합니다. 실용성과 디자인을 겸비한 제품으로, 무겁지 않으면서도 품격있는 중역 공간을 완성합니다. Unlike traditional, heavy executive furniture, the 4LEG type desk enables a light and stylish design. It offers a wide range of color options, from bright and lively to dark and dignified. Various configurations, from side storage cabinet types to large built-in cabinet styles, allow for customization to suit different spaces and atmospheres. This product combines practicality and design, completing an executive space that is both elegant and lightweight.



### 01. 넉넉한 배선 시스템 Extensive Wiring System

3구 콘센트 / 2구 USB / 2구 랜포트 구축 스마트 기기충전, 컴퓨터 및 인터넷 사용에 용이합니다.  
Easy to charge smart devices, use computers and Internet with 3-socket outlet / double USB ports / double LAN ports.



### 02. 160도 상판 책상 160° Tabletop Desk

책상은 160각도 상판 적용하여 작업자가 활동 반경 내에 작업이 용이하도록 설계하였습니다. (옵션)  
With 160-degree top plate, the desk is designed to facilitate work within the radius of the activity for user (Optional).



### 03. 수납 잠금 장치 Cabinet Lock

책상 하부장 도어 내 속서랍에는 잠금 장치를 적용하여 중요한 물건 보관에 용이합니다.  
The desk's lower cabinet door includes a drawer with a locking mechanism, facilitating the secure storage of important items.

## Space Planning



### 01. 일체형 양개 덕트 Integrated Dual-Opening Duct

상판과 동일한 목재 덕트로 일체감을 주고, 양방향 오픈형으로 편의성을 더했습니다.  
The top panel features a wood duct that matches the material, enhancing unity and adding convenience with its bi-directional open design.

### 02. 편리한 옷장 구성 Convenient Closet Options

옷장 도어의 거울로 옷매무새 정돈과 액세서리 걸이로 소품 보관이 편리합니다.  
The wardrobe door includes a mirror for adjusting appearance and hooks for convenient accessory storage.



### 03. 플랩 도어 캐비닛 Flap-Door Cabinet

플랩 힌지를 적용하여, 안전하고 부드러운 사용감을 경험할 수 있습니다.  
Equipped with flap hinges, it offers a safe and smooth user experience.

### Office-One - ALT1

#### Floor Plan

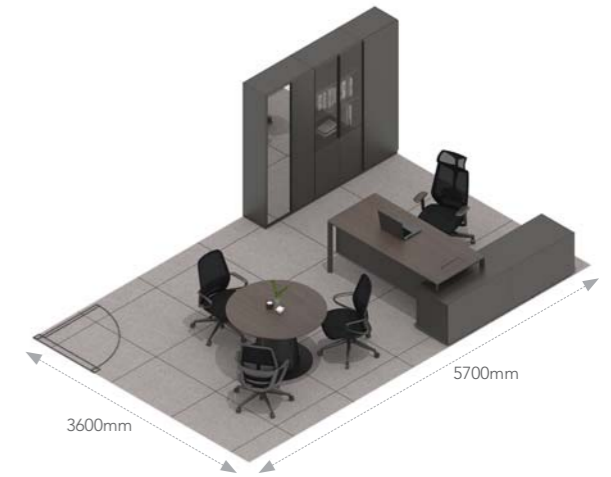
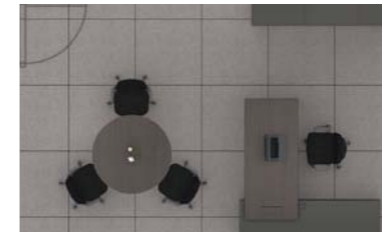

#### Desk Zone



일자수납책상  
H057938  
1EA



사이드 수납장  
H053117  
1EA



은경 책장  
H057445  
1EA



상하부 책장  
H057451  
1EA



옷장  
H057473  
1EA



ARCO  
H029513  
1EA

#### Meeting Zone



원형 테이블  
(출시 예정)  
1EA



어센트  
H054508  
3EA

### Office-One - ALT2

#### Floor Plan

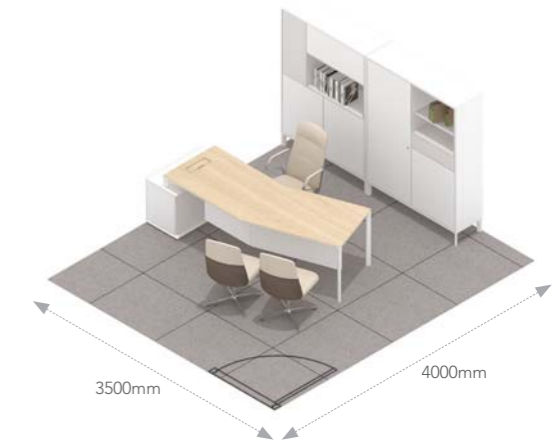

#### Desk Zone



160도 수납책상  
H057937  
1EA



책장 장식장  
H057942  
1EA



옷장 장식장  
H057944  
1EA



VALIOSO  
H042593  
1EA



VALIOSO  
H040597  
2EA

## Space Planning

### Office-One - ALT3

#### Floor Plan

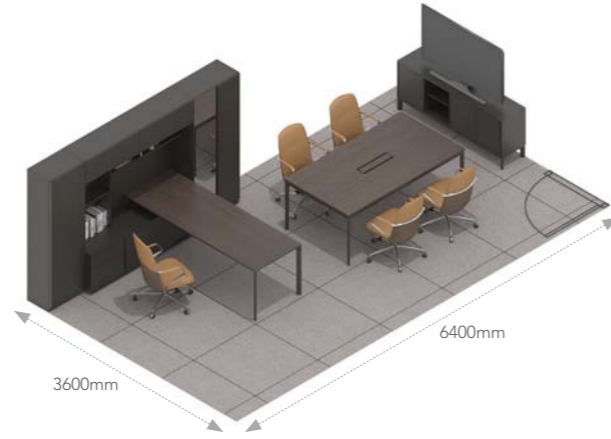

#### Desk Zone



일자 불박이형책상  
H057952  
1EA



은경 책장  
H057445  
1EA



옷장  
H057472  
1EA



VALIOSO  
H042592  
1EA

#### Meeting Zone



중역회의테이블  
H057932  
1EA



크레덴자  
H057947  
1EA



VALIOSO  
H040584  
4EA

### Office-One - ALT4

#### Floor Plan



#### Desk Zone



일자수납책상  
H057939  
1EA



사이드 수납장  
H053119  
1EA



책장 장식장  
H057942  
1EA



옷장 장식장  
H057944  
1EA



HAWORTH  
1EA

#### Meeting Zone



크레덴자  
H057946  
1EA



낮은 테이블  
H051908  
1EA



테이블  
H051909  
1EA



RS7 701G  
OSAO70110IV  
4EA

## Space Planning

### Office-One - ALT5

#### Floor Plan

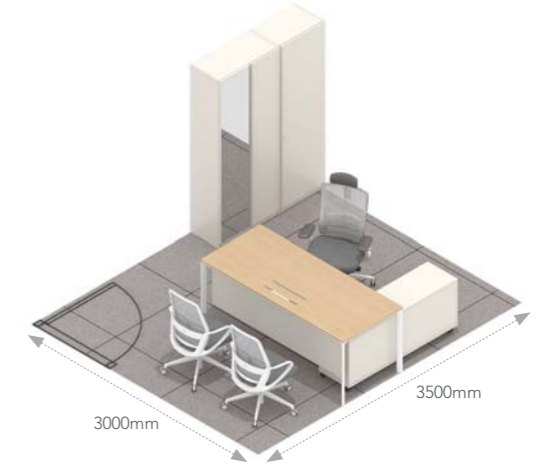

#### Desk Zone



양수 책상  
H055827  
1EA



이동식 하부장  
H052489  
1EA



은경 책장  
H057446  
1EA



옷장  
H057475  
1EA



TECHNIC(싱글헤드형)  
H043964  
1EA



ASCENT(미들백)  
H054505  
2EA

### Office-One - ALT6

#### Floor Plan

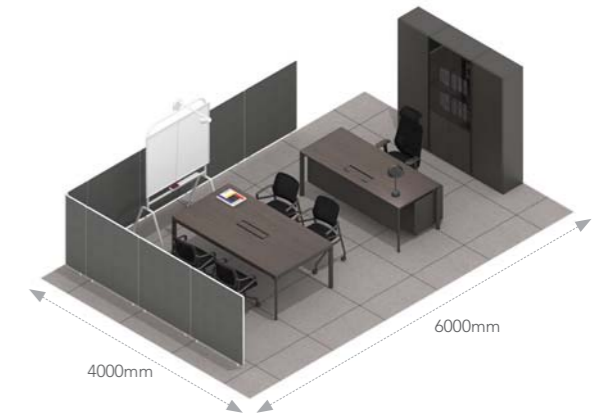

#### Desk Zone



양수 책상  
H055826  
1EA



2단 서랍박스  
H052486  
1EA



책장  
H057460  
1EA



상하부 책장  
H057451  
1EA



옷장  
H057473  
1EA



ARCO  
H029513  
1EA



30T 파티션  
H030243  
6EA



30T 파티션  
H030587  
6EA



중역회의테이블  
H057932  
1EA



이동형 화이트보드  
H028763  
1EA



VATO  
H048835  
4EA

## Office-One

\* 중역 키 세트 별도 주문 가능 (코드 별책 참고)

### Miniaturization 소형화



양수책상 Double Pedestal Desk  
Color. WN / UOA / MIV  
1900 · 800 · 757



2단 서랍박스 2-Level Drawer  
Color. WN+MBK / UOA+MIV / SW+MIV  
400 · 550 · 599



이동식 하부장 Mobile lower cabinet  
Color. WN+MBK / UOA+MIV / SW+MIV  
1450 · 400 · 619

### Renewal 리뉴얼



\* 좌형(L Type)  
160도 수납책상 160 Degree Storage Desk  
Color. MBK+WN / MIV+UOA  
2412 · 1058 · 757  
\* BIS 덕트 적용 (3구+2USB+2LAN) 별도 모델 현장부착



\* 좌형(L Type)  
일자수납책상 Straight Line Storage Desk  
Color. MBK+WN / MIV+UOA  
2088 · 1058 · 757  
\* BIS 덕트 적용 (3구+2USB+2LAN) 별도 모델 현장부착



OFFICE-ONE 전동 사이드 책상  
OFFICE-ONE Electric Side Desk  
Color. MBK+WN / MIV+UOA  
1200 · 590 · 727-1227



\* 우형(R Type)  
160도 불박이형책상 160 Degree Built-In Desk  
Color. MBK+WN / MIV+UOA  
2347 · 1850 · 1935  
\* BIS 덕트 적용 (3구+2USB+2LAN) 별도 모델 현장부착



\* 우형(R Type)  
일자 불박이형책상 Straight Line Built-In Desk  
Color. MBK+WN / MIV+UOA  
2024 · 1850 · 1935  
\* BIS 덕트 적용 (3구+2USB+2LAN) 별도 모델 현장부착



중역회의테이블 Executive Conference System  
Color. MBK+WN / MIV+UOA  
2100 · 1000 · 757  
\* 직사각 형태 Rectangular



원형 테이블 Round Table  
Color . WN+BK / UOA+IV  
Ø1200 · H738



\* 좌형(L Type)  
사이드 수납장 Side Cabinet  
Color. MBK / MIV  
1058 · 565 · 616

Color/Material



## Office-One

\* 중역 키 세트 별도 주문 가능 (코드 별책 참고)



크레덴자 Credenza  
Color. MBK / MIV  
1800 · 400 · 860



책장 장식장 Bookcase Display Cabinet  
Color. MBK / MIV  
1200 · 400 · 1935



옷장 장식장 Closet Display Cabinet  
Color. MBK / MIV  
1200 · 400 · 1935



\* 우형(R Type)  
책장 Bookcase  
Color. MBK / MIV  
600 · 400 · 1935



\* 우형(R Type)  
옷장 Wardrobe  
일반키/전자키 General Key/Digital Key  
Color. MBK / MIV  
600 · 400 · 1935



상하부 책장  
Four-Door Bookcase  
Color. MBK / MIV  
800 · 400 · 1935



은경 책장 Mirror Door Bookcase  
Color. MBK / MIV  
800 · 400 · 1935



측면 마감 패널 Side End Panel  
Color. MBK / MIV  
400 · 1935 · T18  
\* 2개 세트 (2EA 1SET)

Color/Material



# MONTER<sup>몬테</sup>



Softly curved design with a blend of wooden and natural colors creates a new executive space

부드러운 이미지의 곡선 디자인, 원목과 네추럴한 컬러의 조화가 보여주는 새로운 중역 공간

따뜻한 내추럴 CMF를 적용해 홈라이크 오피스 트렌드를 반영한 젊은 임원 공간을 제공합니다.  
또한 유기적인 곡선 라인의 상판은 몬테 그룹의 핵심 디자인 요소로, 세련되면서도 부드러운 무드를 완성합니다.  
Featuring warm natural CMF, a youthful executive area is offered that reflects the home-like office trend.  
Additionally, the organic curved lines of the tabletop serve as a core design element of the Monter Group, completing a sophisticated yet gentle mood.



데스크(DW), 익스텐션(DW), 회의테이블(DW), 유리도어 책장, 크레덴자, 옷장  
\* 현대 L&C 인테리어 마감재 사용

# MONTER

비대칭 형태의 넓고 시원한 곡선형 상판은 공간을 더욱 품격있게 연출하며, 감싸 안는 듯한 디자인으로 시각적 안정감을 높여 편안하고 안락한 업무 환경을 제공합니다. The asymmetrical wide and refreshing curved top adds elegance to the space, and the encompassing design provides visual stability, offering a comfortable and cozy work environment.



**01. 빗각형 하부 가림판**  
Diagonal Lower Cover Panel

패브릭 하부 가림판은 빗각 형태로 설계되어 안락하면서도 세련된 실루엣을 제공합니다. The fabric lower cover panel is designed in a diagonal shape, providing a comfortable yet sophisticated silhouette.



**02. 브릿지형 덕트 박스**  
Bridge-Type Duct Box

늘어나는 전자기기 활용을 위해 수납장에 추가 플러그를 제공하여 편리함을 더했습니다. Additional plugs in the storage cabinet for the increasing use of electronic devices enhance convenience.



**03. 히든형 캐스터 서랍**  
Hidden Casters Drawer

캐스터가 부착된 이동서랍으로 편리한 업무 환경을 조성합니다. The attached casters on the mobile drawers facilitate a convenient working environment.



**01. 케이블 매니지먼트**  
Cable Management

리바트만의 케이블 매니지먼트를 추가하여 깔끔한 전선 정리가 가능합니다. LIVART's unique cable management system allows for tidy cable organization.



**02. 다양한 수납의 크레덴자**  
Credenza with Various Storage

크레덴자는 상부 낮은 서랍과 하부 깊은 선반으로 다양한 물건 보관은 물론 뒷판의 배선홀 시스템으로 전선을 깔끔하게 정리할 수 있습니다. The credenza features a low upper drawer and a deep lower shelf for storing various items, complete with a back panel wire hole system for neat cable organization.



**03. 시리즈 맞춤 공용장**  
Series-Customized Common Storage

캐비닛류 또한 콤비 모델로 조합 가능하여 전체적인 룸의 통일성을 유지합니다. The cabinet types can also be combined into a combi model, maintaining the overall uniformity of the room.

# Space Planning

## MONTER - ALT1

### Floor Plan

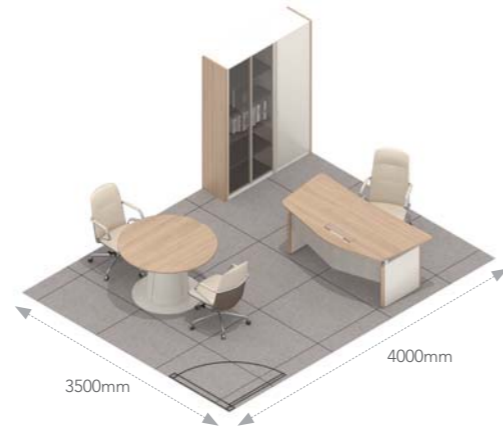

### Desk Zone



### Meeting Zone



## MONTER - ALT2

### Floor Plan

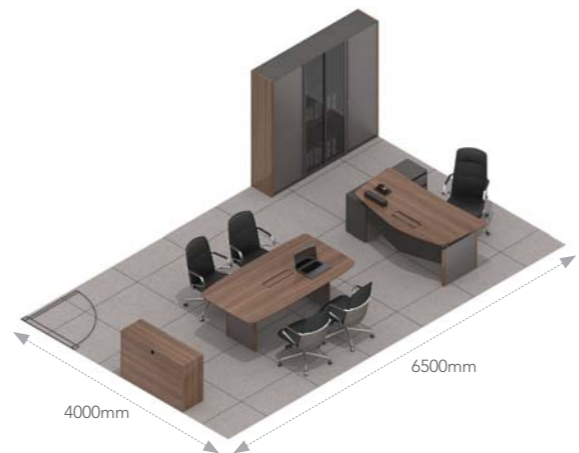

### Desk Zone



### Meeting Zone



# MONTER

\* 중역 키 세트 별도 주문 가능 (코드 별책 참고)



데스크  
Desk  
Color. LW / DW  
1898 · 959 · 750



수납 데스크  
Storage Desk  
Color. LW / DW  
1998 · 1400 · 750



몬테 전동식 수납 책상  
Monter Electric Storage Desk  
Color. LW / DW  
1989 · 958 · 709 ~ 1209



익스텐션 Extension  
Color. LW / DW  
1200 · 496 · 750



2/3단 이동서랍 2/3 Level Movable Drawers  
Color. LW / DW  
352 · 500 · 605



크레덴자 Credenza  
Color. LW / DW  
1200 · 400 · 775



회의테이블 Conference Table  
Color. LW / DW  
1800 · 950 · 750 / 2100 · 1100 · 750



원형 테이블 Round Table  
Color. LW+IV / DW+BK  
Ø1200 · 745



책장 Bookshelf  
Color. LBE / DG  
600 · 400 · 1935



옷장 Wardrobe  
일반키/전자키 General Key/Digital Key  
Color. LBE / DG  
600 · 400 · 1935



상하부 책장  
Four-Door Bookcase  
Color. LBE / DG  
800 · 400 · 1935



은경 책장  
Mirror Door Bookcase  
Color. LBE / DG  
800 · 400 · 1935



측면 마감 패널 Side End Panel  
Color. LW / DW  
400 · 1935 · T18  
\* 2개 1세트 (2EA 1SET)



유리 도어 책장 Glass Door Bookcase  
Color. LBE / DG  
800 · 400 · 1935



# MOTION DESK 모션 데스크

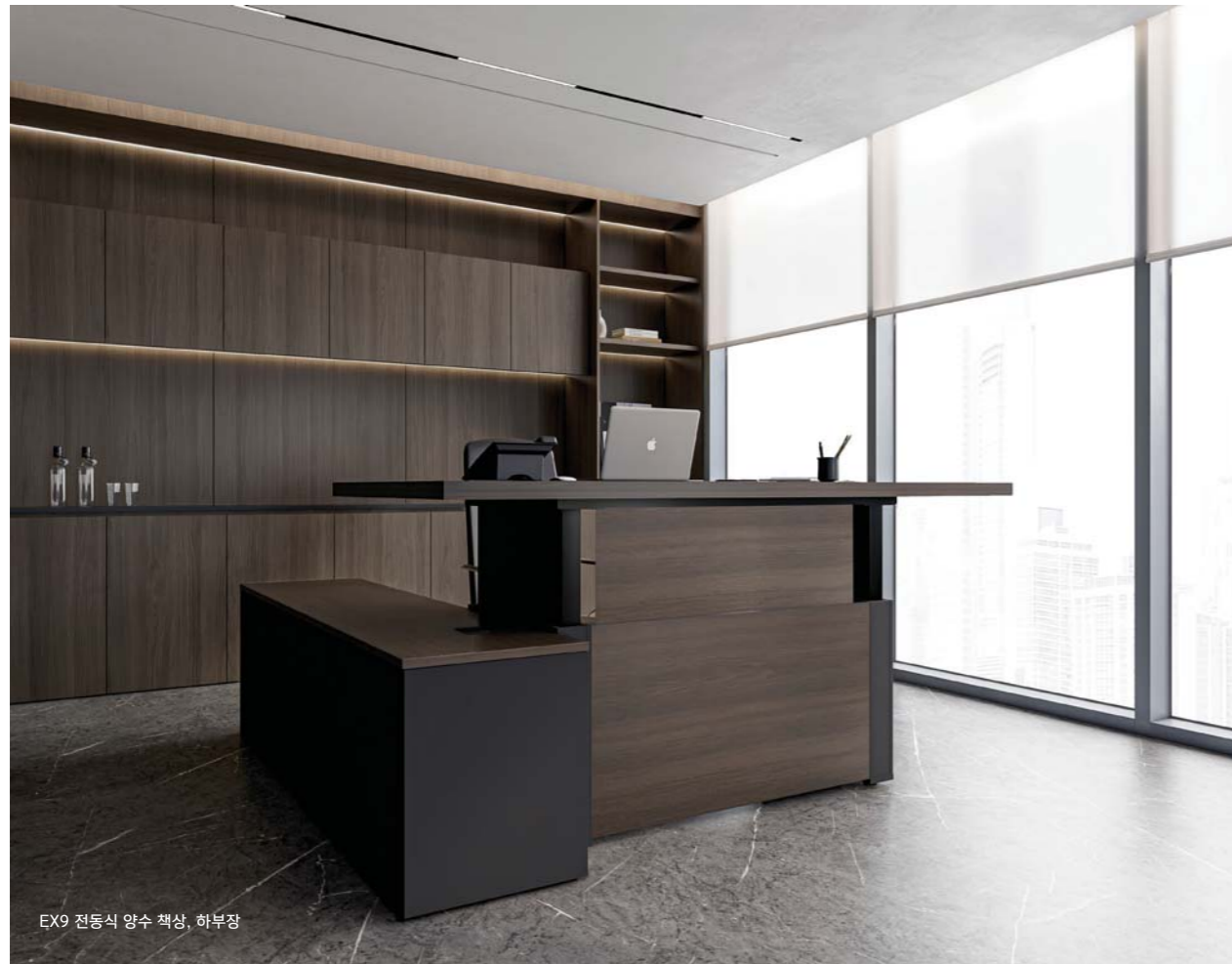

EX9 전동식 양수 책상, 하부장



EX9 전동 사이드 책상, 양수 책상, 서랍, 크레덴자, 책장, 상하부책장, 옷장

Executive

Laminate

MOTION DESK



01. 시리즈 맞춤 전동 데스크  
Custom Series Adjustable Desks

높낮이 조절을 통해 업무 효율을 높일 수 있으며, 자연스럽게 업무 자세를 변경할 수 있습니다.  
Work efficiency can be improved through height adjustment, and working posture can be changed naturally.

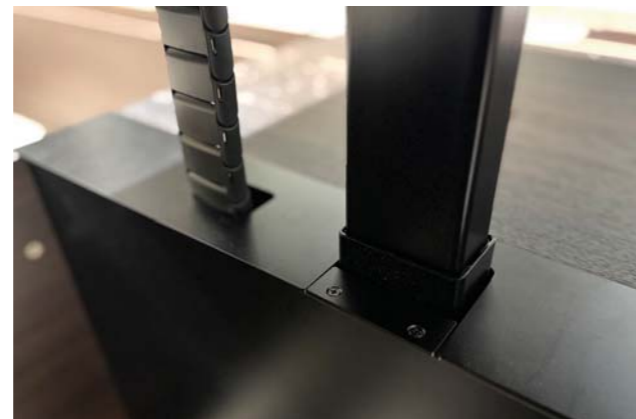

02. 수직 배선 구조  
Vertical Wiring Structure

케이블 매니지먼트를 통해 수직 배선 정리가 용이하며, 배선을 내부로 숨겨 발걸림 없이 사용할 수 있습니다.  
Cable management makes it easy to organize vertical cables, and by hiding the cables inside, you can use the product without tripping over them.



01. 확장된 작업 공간  
Expanded Workspace

사이드 책상을 통해 넓은 작업 면적을 확보할 수 있으며, 스틸 절곡으로 차별화된 다릿발 디자인을 제공합니다.  
The side desk provides a expanded workspace and features a distinctive leg design created through steel bending.



02. 뒷가림판  
Back panel

뒷가림판을 통해 하부 프라이버시를 확보할 수 있으며, 깔끔한 하부 공간을 제공합니다.  
A back panel ensures privacy at the bottom and provides a clean lower space.

## Space Planning

### MOTION DESK – ALT1

#### Floor Plan

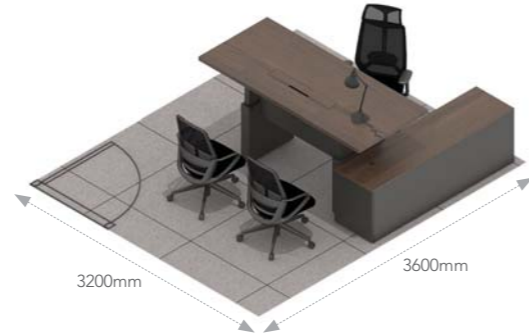
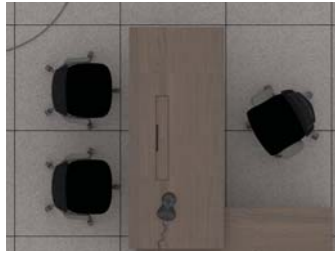

#### Desk Zone



## Space Planning

### MOTION DESK – ALT2

#### Floor Plan



#### Desk Zone



#### Meeting Zone



## MOTION DESK

### 전동식 책상 Electric Height-adjustable Desk



몬테 전동식 수납 책상  
Monter Electric Storage Desk  
Color. LW / DW  
1989 · 958 · 709 ~ 1209



EX9 전동식 양수 책상  
EX9 Electric Lift Desk  
Color. SOA / AOA  
2100 · 900 · 723~1223

### 전동 사이드 책상 Electric Height-adjustable Side Desk



EX9 전동 사이드 책상  
EX9 Electric Side Desk  
Color. SOA / AOA  
1200 · 590 · 723~1223



OFFICE-ONE 전동 사이드 책상  
OFFICE-ONE Electric Side Desk  
Color. WN / UOA  
1200 · 590 · 727~1227

# Office TABLE

## CONFERENCE



EC9 900 GROUP 108



HC7 700 GROUP 112



HC5 500 Group(조합형) 116



HC5 500 Group(독립형) 120



Voluto Conference 124



Office-One Conference 128



Hub-T 130



Wireless Meeting Solution 136

## SEMINAR



SWING 140



CLECS 142

# EC9 900 Group



Functionality that meets the standards of the era of globalization, and an individualistic feel

국제화 시대에 걸맞은 수준 높은 기능성, 개성있는 분위기

깊이 있고 중후한 컬러로 편안한 회의실을 완성시켜주는 EC9 900 Group  
사용자의 편의를 최우선으로 한 최고 사양으로 국제화 수준에 걸맞은 회의용 테이블입니다.

EC9 900Group completes comfortable conference room with  
dark color. International standard conference table with best materials.



## EC9 900 Group

중후하고 고급스러운 분위기로 임원회의실 등에 잘 어울리는 EC9 900 Group. 어떤 크기의 장소에서도 가장 적합한 구조로 구성할 수 있는 시스템 회의용 테이블입니다.

Perfect for executive conference rooms, the conference tables create a dignified and luxurious atmosphere.



### 01. 회의용 전선 덕트 Conference Duct

빠르고 원활한 회의 진행을 위해 전선 덕트를 사용하였습니다.  
Duct is used for quick and efficient conference.

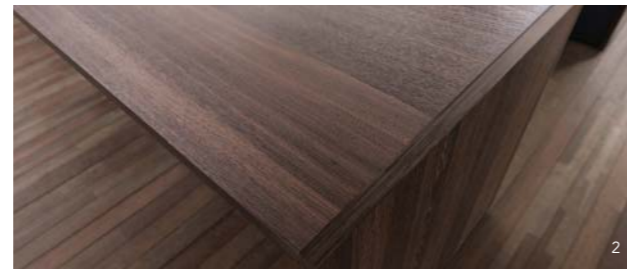

### 02. 무늬목 마감형 다리 Veneer-Finished Legs

EC9 900 Group의 SOA 무늬목 다리는 양쪽 끝에 배치되어 마감패널 역할을 해줍니다.  
EC9 900G's veneer leg functions as finish panel.



### 03. U자/V자형 코너 상판 U-shaped/V-shaped Corner Tops

코너 상판은 레이아웃에 맞춰 조합할 수 있도록 85도와 90도 타입으로 구성되어 있습니다.  
Corner board is consisted with two types 85° and 90° for various layout.



### 04. 중간 다리발 Middle Leg

조합형 테이블의 연결부에 위치한 중간 다리발은 알루미늄 브라켓과 조합하여 상판을 견고하게 지탱해줍니다.  
Legs connect combination table and support upper board firmly with aluminum bracket.

## EC9 900 Group



1000 회의 테이블(LAN/LAN+HDMI 타입)  
1000 Conference System(LAN/LAN+HDMI Type)  
Color. SOA  
1000 · 750 · 709



1600 회의 테이블(LAN/LAN+HDMI 타입)  
1600 Conference System(LAN/LAN+HDMI Type)  
Color. SOA  
1600 · 750 · 709



2200 회의 테이블(LAN/LAN+HDMI 타입)  
2200 Conference System(LAN/LAN+HDMI Type)  
Color. SOA  
2200 · 750 · 709



코너형 Corner Type  
Color. SOA  
800 · 800 · T47(85°/90°)



연결패널 Panel for Connection  
Color. SOA  
85°/90°



다리(마감형) Leg(End Type)  
Color. SOA  
750 · T47 · 709

\* 좌형(L Type)



다리(중간형) Leg(Middle Type)  
580 · T48 · 590



하부철재덕트 Lower Steel Duct  
W1000/1600/2200



SOA / VENEER

SOA / LPM

# HC7 700 Group



The simple structure for extension and modification,  
modern minimalism design

확장과 변이가 용이한 구조, 모던한 미니멀리즘 디자인

심플한 컨템퍼러리 디자인에 회의공간의 크기에 따라 쉽게 확장할 수 있는 기능을 갖춘 회의용 테이블. 글로벌 시대에 어울리는 첨단 디자인 감각과 매립형 전선 덕트 등 뛰어난 기능성으로 회의실을 '미래 창조 공간'으로 꾸며드리는 HC7 시리즈.

A clean, contemporary design easily adapted to any size space.  
The HC7 series creates a forward looking creative space with a cutting edge design and excellent functionality.



# HC7 700 Group



알루미늄 일개형 덕트 콘센트는 랜포트, 연장용 콘센트 1구, 5구 콘센트 사용이 가능합니다.

This aluminum single-door duct socket-outlets are available with a LAN port, a socket for series and 5 sockets-outlet

# HC7 700 Group



**스타터(U형 상석) Starter(U Type Head Table)**  
Color. WH  
2200 · 750 · 720



**코너 애더 Corner Adder**  
Color. WH  
2290 · 750 · 720  
\* 이미지 유형 / 상석 착석 기준



**애더 Adder**  
Color. WH  
1690/2490 · 750 · 720



**엔더 Ender**  
Color. WH  
1600/2400 · 750 · 720



**마감 측면 Finished Side Panel**  
Color. WH  
750 · 707 · 30



**모듈 기본형 Basic Module**  
Color. WH  
4500 · 2300 · 720

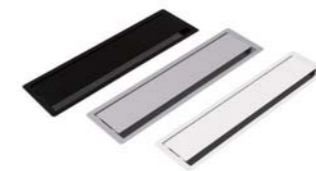

**AL 일개형 덕트 Aluminum Single Duct**  
Color. Black / Silver / White

Color/Material



WH / PAINTING

# HC5 500 Group (조합형)

HC5 enhances the value of communication in meetings of various types

HC5는 회의공간에서의 소통의 가치를 높입니다

자유로운 소통환경을 위한 자유로운 레이아웃 배치와 조합구성으로 회의실의 크기와 구조에 제약받지 않는 효율을 주며 차별화된 디자인으로 특별한 회의실을 구현합니다.

The overall layout of conference tables can be changed easily through a diverse combination of individual tables. The user no longer needs to be restrained due to the size and other characteristics of his/her conference rooms.



# HC5 500 Group (조합형)

## 회의실 시스템 모듈구성 Conference System Module

- ① 테이블-일자형 + 다릿발 추가      ⑤ 테이블-코너형  
Straight + Legs                      Corner Adder - L Type
- ② 테이블-일자형                      ⑥ 테이블-코너형  
Straight                                  Corner Ender
- ③ 테이블-코너형                      ⑦ 테이블-코너형  
Corner Adder - R Type              Corner Starter
- ④ 상석테이블-V자형                  ⑧ 상석테이블-U자형  
V-shape Adder                          U-shape Adder

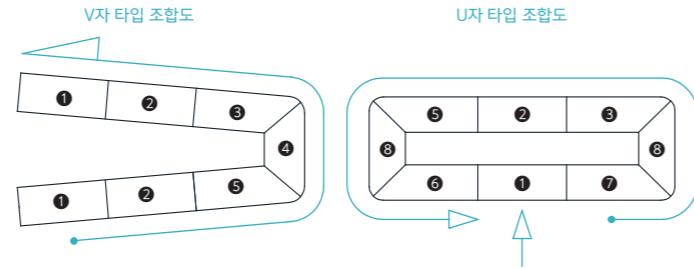

### 01. 조합형 테이블 모듈 Combination Table Module

유닛으로 구성된 시스템 컨퍼런스 테이블로 공간의 크기에 꼭 맞게 구성, 배치할 수 있습니다.  
The unit-based conference system table enables the user to create a conference environment best suited to the size of the given space.



### 02. 다리 간섭 최소화 구조 Design to Minimize Leg Interference

다리걸림이 최소화될 수 있도록 디자인된 다이캐스팅 다릿발은 사용자의 움직임의 활동폭이 넓게 배려하였습니다.  
The die-cast table legs are designed to prevent the user from stumbling into it and maximize his/her freedom of movement.

### 03. 클립형 콘센트 Clip-On Outlet













상판 위에 연결하여 사용할 수 있는 콘센트로 멀티미디어 기기 사용에 최적의 사용성을 제공합니다.  
A movable socket placed on the table enables the user to tap into a variety of multimedia devices at the same time.



### 04. 사이드 가림판 Side Panel

U형/V형 타입에 적용된 사이드 가림판은 개인 프라이버시 및 회의실의 웅장함을 더할 수 있습니다.  
The side screen used for a U-shape / V-shape table arrangement not only enhances the user's privacy but also adds to the integrity of the entire conference room.

# HC5 500 Group (조합형)

 <p><b>테이블 일자형 Table Straight Type</b> Color. SW / WOA / UOA Frame. SV / WH / SBK 800/1200/1600 · 650 · 730 * 스타터 / 독립형으로 배치시 다릿발 1EA 주문 필요</p>	 <p><b>테이블 코너형 스타터 Table Corner Type Starter</b> Color. SW / WOA / UOA Frame. SV / WH / SBK 1877 · 650 · 730</p>	 <p><b>테이블 코너형 애더 Table Corner Type Adder</b> Color. SW / WOA / UOA Frame. SV / WH / SBK 1877 · 650 · 730 <small>* 좌형(L Type)</small></p>
 <p><b>테이블 코너형 엔더 Table Corner Type Ender</b> Color. SW / WOA / UOA Frame. SV / WH / SBK 1877 · 650 · 730</p>	 <p><b>테이블 코너형 1/4 원 코너 애더 Table Corner Type 1/4 Circle Shape Corner Adder</b> Color. SW / WOA / UOA Frame. SV / WH / SBK 650 · 650 · 730</p>	 <p><b>U자형 상석테이블 애더 U Shape Head Table Adder</b> Color. SW / WOA / UOA Frame. SV / WH / SBK 1754 · 650 · 730</p>
 <p><b>V자형 상석테이블 애더 V Shape Head Table Adder</b> Color. SW / WOA / UOA Frame. SV / WH / SBK 1649 · 650 · 730</p>	 <p><b>테이블 스크린(하부가림판) Table Privacy Screen (Blocks Upper Side)</b> 상석 테이블용 for Table or Top Seat W800 / W1200 / W1600 코너용 for Corner Table Color. PE75 * 별도 주문 필요 * 테이블 코너형 : W1600</p>	 <p><b>사이드 가림판 Table Privacy Screen</b> Color. SW / WOA / UOA 650 · 380 · 12 * 좌우 마감 1SET</p>
 <p><b>콘센트 Socket</b> 2/3/4구 2/3/4 Socket</p>	 <p><b>다릿발 Legs</b> Frame. SV / WH / SBK</p>	 <p>SW+SV      WOA+WH UOA+SBK      상판+다릿발 조합 Top+Legs Combination</p>

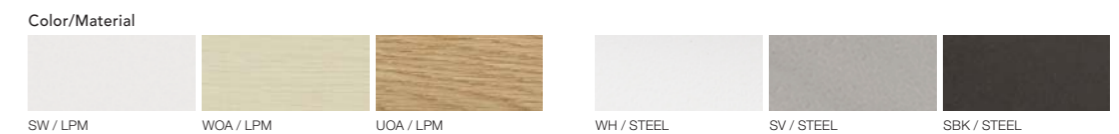

# HC5 500 Group (독립형)



The practical conference table available for various meeting space with trendy design

트렌디한 디자인과 다양한 회의공간에 배치가능한 실용적인 회의테이블

밝고 화사한 느낌으로 유쾌한 소통의 공간으로 회의시간을 바꾸어 드립니다.

독립형 모듈로 구성되어 6인용부터 16인용까지 공간의 크기에 맞게 구성, 배치할 수 있어 소규모 회의실 뿐 아니라 대형 중역회의실까지 다양한 회의실을 연출할 수 있습니다.

With a bright beautiful atmosphere the package delivers, the set helps transform business meetings into hours of pleasant communication between people. Independent modules can easily accommodate the needs for a meeting of 6 to 16 people. Thus the package is suited not just to a small meeting room but also to large-scale executive conference halls.



# HC5 500 Group (독립형)



테이블 (SW)



## 01. 다릿발 컬러 옵션 Leg Color Options

다양한 컬러 옵션으로 원하는 색상 조합이 가능하며, 글라이더로 높이 조절이 가능합니다.

Three color variations allow users to combine their favorite colors, and the height can be adjusted with a glider.



\*5+1구 1LAN 1HDMI 2USB

## 02. 양방향 오픈형 목재 덕트 Two-Way Open Wooden Duct

목재 덕트 양개형 콘센트는 5+1구 1LAN 1HDMI 2USB 사용이 가능합니다. (컬러 : SW, WOA, UOA)

The wooden double-opening duct outlet supports the use of 5+1 outlets, 1 LAN, 1 HDMI, and 2 USB.

## [상판+다릿발 조합]

### Top + Legs Combination



SW+SV



WOA+WH



UOA+SBK

# HC5 500 Group (독립형)



1600 단독형 (D950) 1600 Duct Type(D950)  
Color. SW / WOA / UOA Frame. SV / WH / SBK  
1600 · 950 · 730



2000 단독형 (D950) 2000 Duct Type(D950)  
Color. SW / WOA / UOA Frame. SV / WH / SBK  
2000 · 950 · 730



2000 단독형 2000 Duct Type  
Color. SW / WOA / UOA Frame. SV / WH / SBK  
2000 · 1200 · 730



2400 단독형 2400 Duct Type  
Color. SW / WOA / UOA Frame. SV / WH / SBK  
2400 · 1200 · 730



3200 연결형 3200 Expand Modular Type  
Color. SW / WOA / UOA Frame. SV / WH / SBK  
3200 · 1200 · 730



4000 연결형 4000 Expand Modular Type  
Color. SW / WOA / UOA Frame. SV / WH / SBK  
4000 · 1200 · 730



4800 연결형/확장형 4800 Modular/Extension Type  
Color. SW / WOA / UOA Frame. SV / WH / SBK  
4800 · 1200 · 730



5600 연결형/확장형 5600 Modular/Extension Type  
Color. SW / WOA / UOA Frame. SV / WH / SBK  
5600 · 1200 · 730

보조형 Auxiliary Type  
Color. SW / WOA / UOA Frame. SV / WH / SBK  
800 · 1200 · 730

### Color/Material

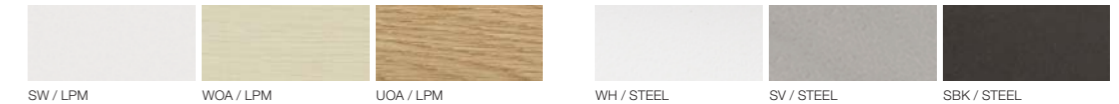

SW / LPM

WOA / LPM

UOA / LPM

WH / STEEL

SV / STEEL

SBK / STEEL

# Voluto Conference 블루투스 회의용



Workzone series supporting different types of work

깊고 넓은 상판으로 다양한 자료를 놓고 원활히 소통할 수 있습니다.

업무 공간 사이 혹은 넓은라운지에 킥미팅 테이블로 활용할 수 있습니다.

Various materials can be placed on the deep and wide tabletop, facilitating smooth communication.

It can be utilized as a quick meeting table within workspace gaps or in a spacious lounge area.



## LOUNGE TABLE



멀티탭형(SW+YE)

### 01. 넓은 업무 면적 Extensive Work Area

넓은 상판으로 자료를 펼쳐 양쪽에서 소통이 가능합니다.  
The wide top allows for spreading out materials, facilitating communication between people seated on either side.



### 02. 슬라이딩 멀티탭 Sliding Power Strip

슬라이딩 멀티탭은 전원 3구+하단1구 전원을 제공합니다.  
The sliding power strip provides three outlets on top and one outlet on the bottom.



### 03. 하부 전선 커버 Lower Wire Cover

하부 커버를 사용하여 깔끔하게 전선을 정리할 수 있습니다.  
When using a multi-tap or other options, the underside wiring can be neatly organized.

## CONFERENCE TABLE



### 01. 위치 조절형 다리발 Adjustable Legs

상석을 사용하는 회의실 등 업무 방식에 맞도록 다리발 위치를 변경할 수 있습니다.  
The leg position can be adjusted to suit the workplace environments like conference rooms where the head seat is used.



### 02. 양방향 오픈형 덕트 Two-Way Open Duct

양방향 개폐형 덕트 커버를 적용하여 사용 편의성을 향상시켰습니다.  
A bidirectional opening and closing duct cover is applied to enhance usability.

## Voluto Conference

### Lounge Table 라운지 테이블



#### 일반형 General Type

Color. SW / WOA / UOA  
Frame. YE / SW / GN / SBK

2400 · 1500 · 730



#### 멀티탭형 Multi-tap Type

Color. SW / WOA / UOA  
Frame. YE / SW / GN / SBK

2400 · 1500 · 730



#### 하부 커버 Lower Cover

Color. GY / SBK

1104 · 300 · 50

\* 2EA 1SET  
\* 라운지 테이블 전용

### Conference Table 회의 테이블



#### 일반형 General Type

Color. SW / WOA / UOA  
Frame. YE / SW / GN / SBK

1500/1800/2100/2400 · 1000 · 730



#### 일반형 General Type

Color. SW / WOA / UOA  
Frame. YE / SW / GN / SBK

3000/3600/4200/4800 · 1000 · 730

#### Color/Material

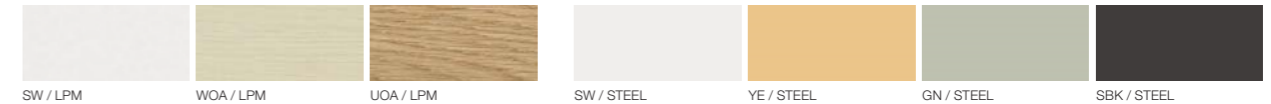

SW / LPM

WOA / LPM

UOA / LPM

SW / STEEL

YE / STEEL

GN / STEEL

SBK / STEEL

# Office-One Conference 오피스원 회의용



Mechanism conference table that fully understands the user needs

사용자의 니즈를 충분히 이해한 메커니즘 회의테이블

10~12인 이하 중형 회의테이블과 4~5인 이하 소형 회의테이블로 시리즈 품목을 같이 구매했을 때, 서로 조화롭게 어우러지는 공간 기획이 가능하도록 설계하였습니다.

It is designed to facilitate harmonizing space plan when purchasing series items of a medium-sized conference table for 10 to 12 persons together with items of a small conference table for 4 to 5 persons. Mechanism conference table that fully understands the user needs



오피스원 회의테이블 소형 (WOA)



오피스원 회의테이블 중형 (SW)



## 01. 중앙 하부장 수납 Center Base Cabinet Storage

중앙 하부장에 IT기기와 복잡한 배선들을 깔끔하게 수납하여 회의 시 편의성을 향상해 줍니다.

It improves the convenience during conference by neatly storing various IT devices and complicated wiring in the central lower cabinet.



## 02. 편리한 착석 구조 Convenient Seating Design

중앙 다리발 없이 하부장과 좌우측 끝단 다리발 4개만 사용하여, 의자 착석 시 장애물이 없어 편리하게 사용 가능합니다.

It provides comfortable seating experience since legroom can be secured and there are no obstacles by using only with the middle lower cabinet and 4 legs at the left and right ends and without center leg.



## 03. 양방향 오픈형 목재 덕트 Two-Way Open-Type Wooden Duct

목재 덕트 양개형 콘센트는 5+1구 1LAN 1HDMI 2USB 사용이 가능합니다.

(컬러 : SW, WOA, UOA, HOA)

The wooden double-opening duct outlet supports the use of 5+1 outlets, 1 LAN, 1 HDMI, and 2 USB.



## 04. 다리발 활용 배선 정리 Wiring Organization Using Leg Supports

책상 다리를 통한 전선의 수직배선이 가능해 많은 전선을 수용할 수 있으며, 후크타입의 커버로 쉽게 이탈되지 않습니다.

It can accommodate a large volume of cables with vertical wiring of the cables through the desk leg and it is not easily separated with the hook type cover.

## Office-One Conference



회의테이블 소형  
Conference System (Small)  
Color. SW / WOA / UOA

1600 · 1200 · 730  
\* 덕트 1EA



회의테이블 중형  
Conference System (Medium)  
Color. SW / WOA / UOA

4000 · 1200 · 730  
\* 덕트 3EA



덕트 하우징 / 목재 덕트 양개형  
Cable Manager / Wood Duct (Double Opening)  
Color. (하우징) SW / BK (커버) SW / WOA / UOA / HOA

(하우징) 640 · 160 · 160  
\* 5+1구 1LAN 1HDMI 2USB

Color/Material





We pursue smart and flexible communication

스마트하고 유연한 커뮤니케이션을 추구합니다

자유로운 스마트 워킹을 추구하고 있는 트렌드에 맞추어 오픈 커뮤니케이션에 적합한 오피스 레이아웃을 추구합니다. 디테일한 소품 하나하나까지 더 고민하여 사용자에게 최상의 솔루션을 제공해드립니다.

In line with the trends of free smart working, we pursue an office layout suitable for open communication. We consider every detail with accessories and provide customers with the best solution.



## Hub-T

확장 및 추가 구성이 가능하며 합리적인 가격과 디자인의 모듈형 테이블로  
 변동좌석제 오피스 직군 또는 회의실 공간, 라운지 빅테이블로 활용이 가능합니다.  
 This modular table is expendable and addable with other items, and have  
 reasonable price. It can be utilized as changeable seating system office group,  
 meeting room space, or lounge big table.



팀테이블(SW), 사물함

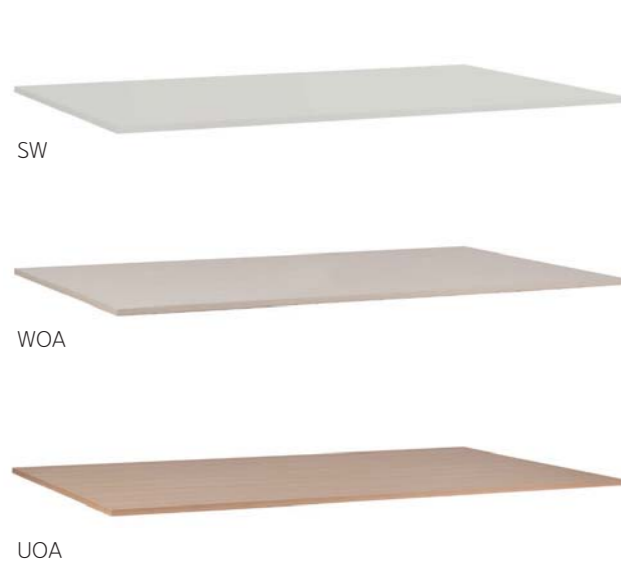

### 상판 4가지, 다릿발 3가지 컬러 옵션 Three color options for upper panel and desk leg

오피스 분위기와 원하는 스타일에 따라 상판, 다릿발 컬러를  
 다양하게 조합할 수 있습니다.  
 You can choose colors for upper panel and desk leg and mix  
 and match to fit your office atmosphere and preference.

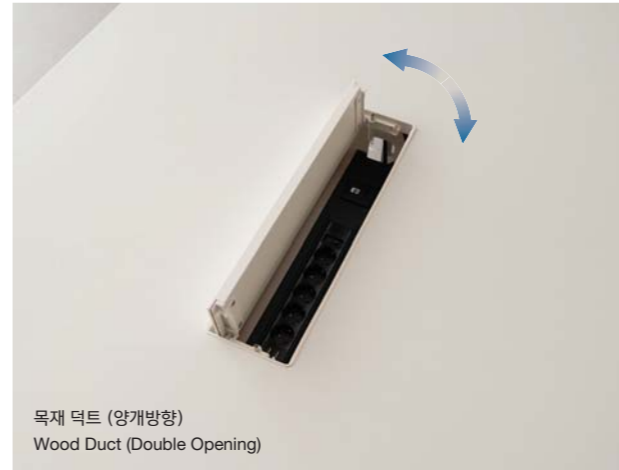

목재 덕트 (양개방향)  
 Wood Duct (Double Opening)

### 01. 양방향 오픈형 목재 덕트 Two-Way Open Wooden Duct

목재 덕트 양개형 콘센트는 5+1구 1LAN 1HDMI 2USB 사용이 가능합니다.  
 (컬러 : SW, WOA, UOA)  
 The wooden double-opening duct outlet supports the use of 5+1  
 outlets, 1 LAN, 1 HDMI, and 2 USB.



### 02. 수평 조절 레벨러 Horizontal Adjustment Leveler

다릿발 바닥면 레벨러 적용하여 제품 설치 환경에 따라 수평을 맞추고 흔들림을  
 방지합니다.  
 The leg leveler keeps the surface of your table horizontal and to prevent  
 it from wobbling.



### 03. 이동형 사이드 스크린 Movable Side Screen

사용자의 착석 형태에 따라 이동형 사이드스크린을 원하는 위치에 설치하고  
 제거하여 공간을 분리해서 사용할 수 있습니다. (옵션)  
 According to the user's seating type, the movable side screen can be  
 installed and removed at the desired position to separate the space.  
 (option)



### 04. 안정적 사선 구조 다릿발 Stable Diagonal Leg Structure

다릿발은 직사각 사선 구조의 안정적인 디자인으로 오랜 기간을 사용해도 선반  
 꺼짐 없이 사용할 수 있도록 하부 구조를 보강하였습니다.  
 The legs have stable rectangular diagonal design and are reinforced  
 so that this table can be used without hollowed shelf even after a long  
 period of use

## Hub-T

Hub-T는 2000, 2400, 2800, 3200, 4000, 4800, 5600 등 자유롭게 사이즈 확장 가능합니다. 모듈화된 구성으로 벤치형 데스크, 회의용 테이블, 빅테이블 등 용도에 따른 제거와 추가가 편리합니다.

The HC 300G can be freely scaled to 2000, 2400, 2800, 3200, 4000, 4800, or 5600. Modular configuration makes it easy to remove and add bench-type desks, conference tables, and big tables.

### A Type

사이즈 : W2000/W2400 x D1100 x H730(조명 제외)  
구성 : W2000/W2400 상판 + 보강바 + 다릿발  
조립 방법 : 다릿발 양쪽 내측 결합

Size : W2000/W2400 x D1100 x H730(Light Excluded)  
Composition : W2000/W2400 Top Panel + Assist Beam + Desk Leg  
Assembling method : Joining on both inner sides of the leg



### B Type

사이즈 : W2800/W3200 x D1100 x H730(조명 제외)  
구성 : W2000/W2400상판 + 보강바(2ea)  
+ W400 확장상판(2ea) + 다릿발  
조립 방법 : 다릿발 양쪽 외측 결합

Size : W2800/W3200 x D1100 x H730(Light Excluded)  
Composition : W2000/W2400 Top Panel + Assist Beam(2ea)  
+ W400 Extended Top Panel(2ea) + Desk Leg  
Assembling method : Joining on both outside sides of the leg



### C Type

사이즈 : W4000/W4800 x D1100 x H730(조명 제외)  
구성 : W2000/W2400상판(2EA) + 보강바(2EA) + 다릿발  
조립 방법 : 다릿발 일면 내측 결합, 일면 외측 결합

Size : W4000/W4800 x D1100 x H730(Light Excluded)  
Composition : W2000/W2400 Top Panel(2ea) + Assist Beam(2ea) + Desk Leg  
Assembling method : Joining on one inner side of the leg  
+ Joining on one outside side



### D Type

사이즈 : W4800/W5600 x D1100 x H730(조명 제외)  
구성 : W2000/W2400상판(2EA) + 보강바(2 SET)  
+ W400확장상판(2EA) + 연장 보강바(2 SET) + 다릿발  
조립 방법 : 다릿발 양쪽 외측 결합

Size : W4800/W5600 x D1100 x H730(Light Excluded)  
Composition : W2000/W2400 Top Panel(2ea) + Assist Beam(2ea) + W400  
Extended Top Panel(2ea) + Extended Assist Beam(2ea) + Desk Leg  
Assembling method : Joining on both outside sides of the leg



## Hub-T



W1600 팀테이블(D950, 기본형/덕트형)  
W1600 Co-Working Table(Standard/Duct)  
Color. SW / WOA / UOA  
Frame. WH / TC / SBK  
1600 · 950 · 730



W2000 팀테이블(D950, 기본형/덕트형)  
W2000 Co-Working Table(Standard/Duct)  
Color. SW / WOA / UOA  
Frame. WH / TC / SBK  
2000 · 950 · 730



W2000 팀테이블(기본형/덕트형)  
W2000 Co-Working Table(Standard/Duct)  
Color. SW / WOA / UOA  
Frame. WH / TC / SBK  
2000 · 1100 · 730



W2400 팀테이블(기본형/덕트형)  
W2400 Co-Working Table(Standard/Duct)  
Color. SW / WOA / UOA  
Frame. WH / TC / SBK  
2400 · 1100 · 730



W4000 팀테이블(기본형/덕트형)  
W4000 Co-Working Table(Standard/Duct)  
Color. SW / WOA / UOA  
Frame. WH / TC / SBK  
4000 · 1100 · 730



W4800 팀테이블(기본형/덕트형)  
W4800 Co-Working Table(Standard/Duct)  
Color. SW / WOA / UOA  
Frame. WH / TC / SBK  
4800 · 1100 · 730



확장 상판 Extend Panel  
Color. SW / WOA / UOA  
400 · 1100 · 23  
\* 1EA 제품  
\* 양측 구성시 2개 주문  
\* D950 설치 불가



사이드스크린 Side Screen  
Color. GY



덕트 하우징 / 목재 덕트 양개형  
Cable Manager / Wood Duct (Double Opening)  
Color. (하우징) SW / BK (커버) SW / WOA / UOA

(하우징) 640 · 160 · 160  
\*5+1구 1LAN 1HDMI 2USB

#### Color/Material



SW / LPM

WOA / LPM

UOA / LPM

WH / STEEL

TC / STEEL

SBK / STEEL

# Livart x Logitech Wireless Meeting Solution

## LOGITECH SCRIBE



\* 로지텍 전문 설치팀 진행, 설치비 별도



1200 이동형 화이트보드  
1200 Movable White Board

1200 · 630 · 2100  
\* 로지텍 스크라이브 별도 주문 필요



1800 이동형 화이트보드  
1800 Movable White Board

1800 · 630 · 2100  
\* 로지텍 스크라이브 별도 주문 필요



수납장 Storage  
Color: SW

1600 · 310 · 760



로지텍 스크라이브  
Logitech Scribe

\* 화이트 보드 주문 시, 별도 주문 필요



- 1 화이트보드 교체가 가능한 공용 타입 프레임에 적용하였습니다.
- 2 볼캐스터가 있어 회의실을 옮겨 다니며 화상회의를 할 수 있는 편의성을 더했습니다.
- 3 스위치 등의 거치가 가능한 브라켓이 구성되었습니다.
- 4 내부로 연결될 수 있도록 설계되어 깔끔한 배선정리가 가능합니다.
- 5 내부 히든 도어, 상부 히든 공간을 활용한 멀티탭 및 어댑터의 깔끔한 배선 정리가 가능합니다.
- 6 다양한 사이즈의 화상 카메라를 수용할 수 있는 넉넉한 사이즈입니다.

- 1 Applied a universal frame so that white boards can be replaced.
- 2 Can be conveniently moved around through the conference rooms with the ball caster and has a video conference feature.
- 3 Includes brackets that can cradle switches and the likes.
- 4 Organized wiring by connecting the wires from the inside
- 5 Can organize the wiring of the outlets and adapters using the inner hidden door and the top hidden space.
- 6 Wide enough to put various sizes of web cams.

화상 회의 장비  
Video Conference Equipment



Logitech

소형 회의실용 화상 회의 카메라  
Small Conference Room Video Conference Camera



MEETUP 2

AI 기능이 탑재된 USB 컨퍼런스 카메라인 MeetUp 2로 직원과 IT 모두에게 효율적인 화상 회의를 제공합니다.

MEETUP 2 is a USB conference camera equipped with AI features, providing efficient video conferencing for both employees and IT.

중소형 회의실용 올인원 비디오 바  
All-in-One Video Bar for Small to Medium Conference Rooms



RALLY BAR MINI

로지텍 Rally Bar Mini는 중소형 회의실을 위한 올인원 비디오 바입니다. AI 기술 내장, 뛰어난 광학 장치, 강력한 오디오를 기능으로, 고품질의 간편한 화상 회의를 제공합니다.

The Logitech RALLY BAR MINI is an all-in-one video bar designed for small to medium conference rooms. It includes AI technology, superior optical devices, and powerful audio features, delivering high-quality and convenient video conferencing.

중대형 협업을 위한 테이블톱 카메라  
Tabletop Camera for Large Collaboration



SIGHT

Sight는 지능형 다중 참여 프레임링을 제공하는 테이블톱 카메라입니다. 중앙 관점에서 최상의 화질을 제공하며, 대화와 비언어적 소통을 선명하게 담아냅니다.

SIGHT is a tabletop camera that offers intelligent multi-participant framing. It delivers optimal image quality from a central perspective, clearly capturing both verbal and non-verbal communication.

# SWING 스윙



Folding table features sensitive design that enhances user concentration and offers a convenient mechanism

## 집중도를 높이는 감각적인 디자인과 편리한 메커니즘

상판을 간단하게 접을 수 있는 편리한 메커니즘은 자유로운 이동과 적층식 구조의 보관으로 사용공간을 더욱 자유롭게 연출합니다.

Folding Table offers a convenient mechanism enabling easy folding. You may utilize the space more flexibly with such features as it can be freely moved and storage in a stacked state.



테이블, 강연대



가림판 부착형 테이블(ABS엣지)



가림판 부착형 테이블(ABS엣지)

## SWING



가림판 부착형 일반형(ABS엣지)  
With the Modesty Panel Normal(ABS Edge)  
Color. SW

1400/1500/1800 · 500 · 745



전면 노출형 일반형(ABS 엣지)  
Without the Modesty Panel Normal(ABS Edge)  
Color. SW

1400/1500/1800 · 500 · 745



강연대 ABS 엣지  
Lecture Table ABS Edge  
Color. G

700 · 500 · 975

Color/Material



SW / LPM

# CLECS 클렉스



Effective information exchange and efficient space application

## 효과적인 정보교류와 효율적인 공간활용

다양한 목적과 규모의 강의환경에 대응할 수 있는 제품구성과 특별한 기능과 디자인으로 최적의 강의 환경을 구현합니다.

It can realize the optimal lecture environment with the product composition dealing with multiple purposes and scale of lecture environment and special functions and design.



테이블 ED300W 의자 EH300

- 1 책상 상판 하부의 레버를 당겨 간편하게 접을 수 있는 폴딩 메커니즘.(적층식 보관)
- 2 의자 폴딩 메커니즘.

- 1 The desk, with a folding mechanism, is easily folded by pulling a lever under the board of the desk. (Stacked storage)
- 2 The chair is equipped with a folding mechanism.

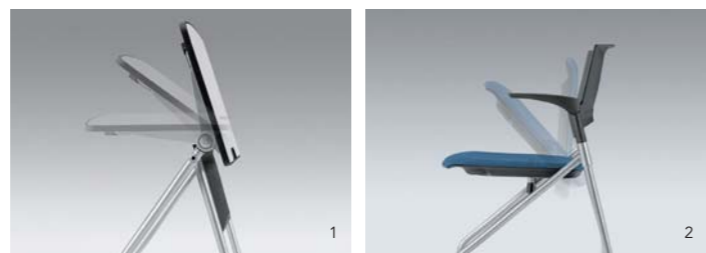

## CLECS



폴딩 테이블  
Folding Table  
Color. SW

700 · 490 · 745  
\* 옛지 2타입: SW 옛지, DG 옛지



폴딩 체어(캐스터 팔걸이형)  
Folding Chair(Caster Armrest Type)  
Color. BU / GY

593 · 537 · 771



폴딩 체어(캐스터형)  
Folding Chair(Caster Type)  
Color. BU / GY

544 · 537 · 771



강연대 Lecture Table  
Color. GY

540 · 567 · 1149



왜건 Lecture Wagon  
Color. GY

540 · 567 · 1149



스크린 Screen  
Color. WH+BK

942 · 674 · 1805

### Color/Material

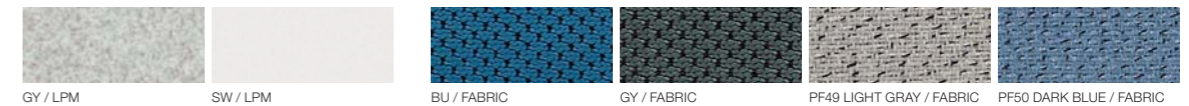

GY / LPM

SW / LPM

BU / FABRIC

GY / FABRIC

PF49 LIGHT GRAY / FABRIC

PF50 DARK BLUE / FABRIC

# Office SEATING

## EXECUTIVE

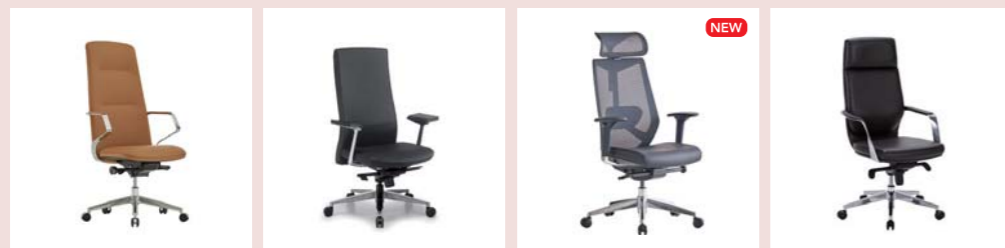

VALIOSO 148 S900G 149 ARCO EX 150 EGARD 151

## TASK

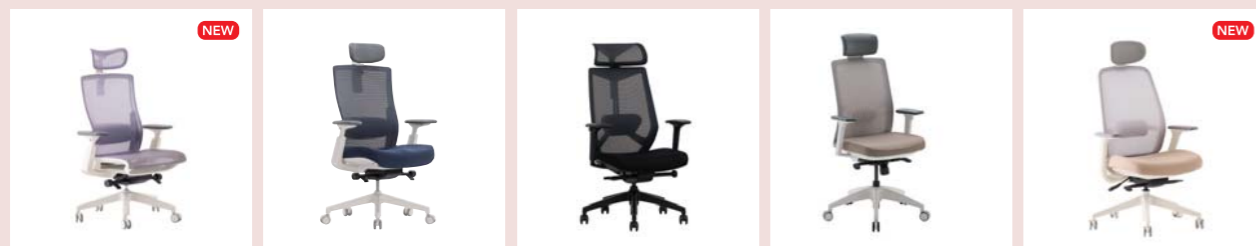

TECHNIC FLOW 158 TECHNIC 159 ARCO 160 T353G 161 ASCENT PLUS 162

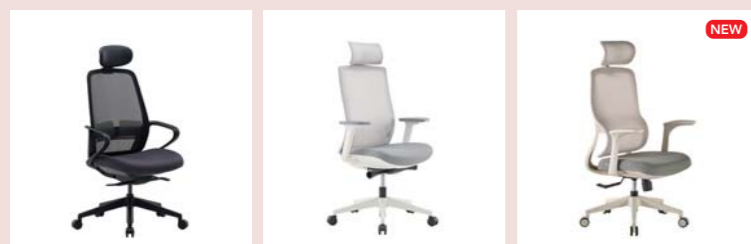

ASCENT 163 BALANCE 164 NEW BOOST 165

## MULTI-USE

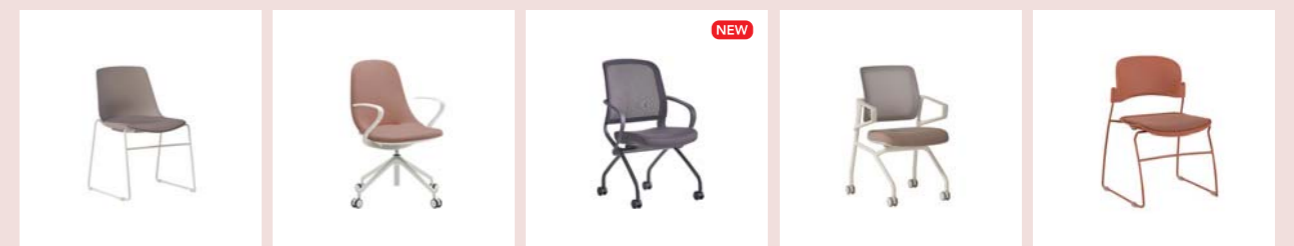

mauve 170 Union Variety 171 GRAB 172 Vato 173 SEMINAR 174



JOEL 175 MEDITIO 175 RIFF 176 PRONTO 176 FIT 177



Comfy 177

# EXECUTIVE

New Age, New Prestige

품위 있는 비즈니스 커뮤니케이션을 위한 리바트 프리미엄 의자



## Executive 임원의자

### Valioso 밸리오소



하이백 타입 High-Back Type  
Finish. Genuine/Artificial Leather  
Color. CM / IV / BK  
W610 D675 H1195~1285



미들백 타입 Mid-Back Type  
Finish. Genuine/Artificial Leather  
Color. CM / IV / BK  
W610 D630 H975~1065



회의 타입 Conference Type  
Finish. Fabric  
Color. BE / GY  
W540 D690 H955~1065  
\*주문제작 필요



오토만 Ottoman  
Finish. Genuine Leather  
Color. CM / IV / BK  
W500 D379 H410~510

### S900



하이백 타입 High-Back Type  
Finish. Genuine/Artificial Leather  
Color. BK  
W710 D620 H1140~1220



미들백 타입 Mid-Back Type  
Finish. Genuine/Artificial Leather  
Color. BK  
W710 D620 H980~1060



헤드레스트 타입 Headrest Type  
Finish. Mesh / Leather  
Color. BK  
W685 D625 H1105~1175



미들백 타입 Mid-Back Type  
Finish. Mesh / Leather  
Color. BK  
W685 D625 H970~1140

### EGARD 에가드



하이백 타입 High-Back Type  
Finish. Leather  
Color. IV / DB  
W655 D630 H1175~1240

# Valioso 벨리오소



슬림해진 부피감과 세련된 디자인으로 공간을 부드럽게 만드는 실루엣의 중역의자. 의자를 휘감듯 자연스럽게 흐르는 팔걸이 프레임으로 우아한 품격을 갖췄습니다. An executive chair with a slimmed-down volume and sophisticated design that softens the space with its silhouette. It features elegant dignity with armrest frames that flow naturally, as if wrapping around the chair.



- 1 사용하기 편안한 각도에서 의자를 고정하는 포지션 락킹(4가지 자세) 원하는 틸팅 최대 범위를 3단계로 설정할 수 있는 리미티드 틸팅
- 2 독일 수입사를 활용, 3중 레이어드 봉제 방식을 통한 높은 완성도
- 3 천연 소가죽을 감싸는 우드 커버와 메탈 밴드, 복잡한 기능부를 심미적으로 가린 높은 디자인 완성도
- 4 사용자의 움직임에 따라 유연하게 움직이는 웨이브슬릿 등판 이너셸

- 1 Position locking that secures the chair at a comfortable angle (4 positions lock) Limited tilting feature allowing the maximum tilting range to be set in three stages
- 2 High-quality craftsmanship using German imported materials, with a triple-layered stitching technique
- 3 High design finish with a wood cover and metal band encasing natural cowhide leather, aesthetically concealing complex functional parts
- 4 A WaveSlit backrest inner shell that flexibly moves in response to the user's movements

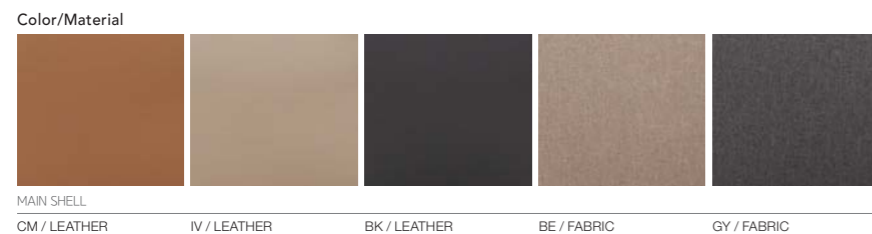

# S900G



고급 가죽에서 우러나오는 품격, 인체공학적 설계에 의한 뛰어난 안락감, 불필요한 장식을 배제한 간결한 디자인으로 탄생한 고급 사무용 의자 S900G. The utmost in class and luxury, with an ergonomic design that guarantees outstanding comfort, the luxury office chair S900G shows the true beauty of absolute simplicity



한국산업디자인상  
Korea Industrial  
Design Awards



- 1 인체의 움직임에 맞추어 등판과 좌판이 각기 다른 각도로 틸팅되는 싱크로나이즈드 틸팅기능과 등판의 기울기가 5단계로 조절되는 멀티 락킹 틸팅기능을 갖추었습니다.
- 2 고급 가죽에서 느낄 수 있는 높은 품격과 함께 등판 뒷부분을 메탈 바를 부착하여 고급스럽습니다.
- 3 팔이 닿는 부분에 넓은면적의 발포우레탄을 사용하여 최적의 안락감을 제공합니다.

- 1 The backrest and seat tilt in a synchronized way according to a user's movements. And it has a multi-locking tilt function to fix the backrest at the desired angle through 5 reclining stages.
- 2 The high quality leather and the metal bar attached on the back add to its class.
- 3 The sizeable armrest covered with polyurethane foam offers the user the highest level of comfort.



# ARCO EX NEW 아르코 이엑스



세계적인 디자이너가 선보인 유니크한 디자인과 함께, 액티브한 임원을 위해 특별히 제작된 기능성 프리미엄 중역 의자입니다. 세련된 외관과 인체공학적 설계가 조화를 이루어 편안함과 스타일을 동시에 제공합니다. This premium executive chair features a unique design by a world-renowned designer, specially crafted for active executives. It combines a sophisticated appearance with ergonomic design to deliver both comfort and style.



1. 품격있는 천연가죽 소재의 좌방석
2. 프리미엄 SUS 스틸 다리 디자인
3. 어깨부터 좌판까지 이어지는 인체공학적 서스펜션 백 프레임
4. 탄성 좋은 폴 메시 와이드 헤드레스트

1. Crafted with high-quality natural leather for a touch of elegance and comfort.
2. A sleek design that combines durability with premium style.
3. Seamlessly supporting from shoulders to seat for optimal posture and comfort.
4. A breathable, highly resilient mesh headrest that provides lasting comfort and support.



# EGARD 에가드



고급스러운 소재의 팔걸이와 슬림한 디자인이 특징인 젊은 감각의 의자입니다. Armrest made of premium material and the slim design of the chair catches the hearts of the young people.



1. 등판과 좌판이 연결되어 있어 틸팅 시 같은 각도로 움직이는 니(Knee) 틸트 기능
2. 좌판 하부 원통 핸들과 좌측 손잡이를 통해 원하는 틸팅 강도와 각도 조절 기능

- 1 The back and the seat are connected for the angles move the same which is one of the features: Knee Tilt
- 2 The tension of the tilt and angle can be adjusted freely with the rotating handle at the bottom and with the handle at the left side respectively



# TASK

Work Smart, Think Smart

업무 효율과 편안한 착석감을 우선으로 생각하는 리바트 업무 의자



## TASK CHAIR 사무용 의자

### TECHNIC FLOW 테크닉 플로우



헤드레스트 타입 Headrest Type  
Finish. MESH / SHIFT MESH  
Color. GY / PU+BU / GN+BU / BK  
WH / BK (Frame)

W690 D565 H1085-1220



미들백 타입 Mid-Back Type  
Finish. MESH / SHIFT MESH  
Color. GY / PU+BU / GN+BU / BK  
WH / BK (Frame)

W690 D565 H990-1180

### TECHNIC 테크닉



싱글 헤드레스트 타입  
Single Headrest Type  
Finish. MESH+FABRIC  
Color. RE / BU / GN / BK  
WH / BK (Frame)

W690 D565 H1125-1215



메시헤드 타입  
Mesh Head Type  
Finish. MESH+FABRIC  
Color. DG / GN  
WH / BK (Frame)

W690 D565 H1085-1220



미들백 타입  
Mid-Back Type  
Finish. MESH+FABRIC  
Color. RE / BU / GN / BK  
WH / BK (Frame)

W690 D565 H990-1180

### ARCO 아르코



헤드레스트 타입  
Headrest Type  
Finish. MESH+FABRIC  
Color. BK / WH

W685 D625 H1105-1175

### T353G



헤드레스트 타입 Headrest Type  
셀프텐션형 틸트 Self Tension Tilt Type  
Finish. MESH+FABRIC  
Color. GY / BE / BK / BU  
WH / BK (Frame)

W645 D565 H1160-1285



헤드레스트 타입 Headrest Type  
일반형 틸트 General Tilt Type  
Finish. MESH+FABRIC  
Color. GY / BE / BK / BU  
WH / BK (Frame)

W645 D565 H1160-1285



미들백 타입 Mid-Back Type  
셀프텐션형 틸트 Self Tension Tilt Type  
Finish. MESH+FABRIC  
Color. GY / BE / BK / BU  
WH / BK (Frame)

W645 D590 H1005-1075



미들백 타입 Mid-Back Type  
일반형 틸트 General Tilt Type  
Finish. MESH+FABRIC  
Color. GY / BE / BK / BU  
WH / BK (Frame)

W645 D565 H985-1080

## TASK CHAIR 사무용 의자

### ASCENT PLUS 어센트 플러스



헤드레스트 타입 Headrest Type  
Finish. MESH+FABRIC  
Color. BE / GY / BK  
WH / BK (Frame)

W650 D590 H1140-1235



미들백 타입 Mid-Back Type  
Finish. MESH+FABRIC  
Color. BE / GY / BK  
WH / BK (Frame)

W650 D590 H985-1080

### ASCENT 어센트



헤드레스트 타입 Headrest Type  
Finish. MESH+FABRIC  
Color. GY / BE / BK / OR  
WH / BK / OR (Frame)

W610 D630 H985-1235



미들백 타입 Mid-Back Type  
Finish. MESH+FABRIC  
Color. GY / BE / BK / OR  
WH / BK / OR (Frame)

W610 D630 H985-1080



로우백 타입 Low Back Type  
Finish. MESH+FABRIC  
Color. GY / BE / BK  
WH / BK (Frame)

W610 D590 H815-910



카운터 타입 Counter Type  
Finish. MESH+FABRIC  
Color. GY / BE / BK  
WH / BK (Frame)

W610 D590 H940-1100

### BALANCE 밸런스



헤드레스트 타입 Headrest Type  
Finish. MESH+FABRIC  
Color. LG / CH

W650 D680 H1065-1200



헤드레스트 타입 Headrest Type  
Finish. MESH+FABRIC  
Color. GY / BK  
WH / BK (Frame)

W675 D600 H1120-1255



미들백 타입 Mid-Back Type  
Finish. MESH+FABRIC  
Color. GY / BK  
WH / BK (Frame)



W675 D600 H1070-1145

### NEW BOOST 뉴부스트

# SPECIFICATION

사무용 의자 사양 비교표  
Office Chair Specification Comparison Chart

\* 상세 사이즈는 측정 방식에 따라 수치가 차이가 있을 수 있습니다. (±20)

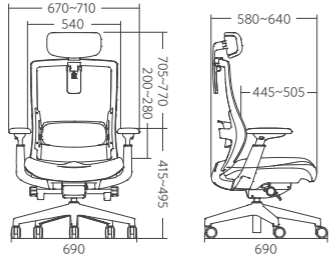
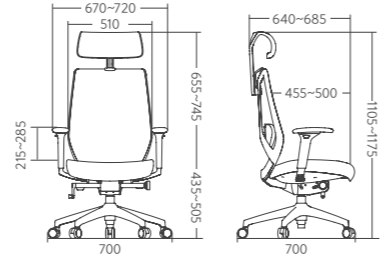
	TECHNIC	ARCO	
제품명 (Product Name)			
제품 상세(Product Details)			
프레임 컬러(Frame Color)	● Black ○ White	● Black ○ White	
등판 컬러(Backrest Color)	● Red   ● Blue ● Green   ● Black	● Midnight Blue Black   ● Gray	
좌판 컬러(Seat Color)	● Red   ● Blue   ● Green   ● Dark Gray	● Black   ● Gray	
상세 사이즈 (Dimensions)			
주요 기능(Key Features)			
틸팅 (Tilting)	틸트(Tilt)	싱크로나이즈 틸트 / 셀프텐션 틸트 / 릴렉스 틸트 (Synchro Tilt / Auto Tilt / Relax Tilt)	싱크로나이즈 틸트 / 셀프텐션 틸트 (Synchro Tilt / Auto Tilt)
	각도조절 (Angle Control)	○ 5단계(5-tiers)	○ 4단계(4-tiers)
	강도조절(Tension Control)	○	○
헤드 레스트 (Headrest)	소재(Material)	인조가죽(Artificial Leather)	메쉬(Mesh)
	높이조절 (Height Control)	○	○
	각도조절 (Angle Control)	○	-
럼버서포트 (Lumber Support)			
팔걸이 (Armrest)	높이조절(Height Control)	○	○
	전후조절 (Front/Back Control)	○	○
	좌우조절 (Left/Right Control)	○	○
	회전(Rotation)	-	-
좌판 (Seat Pad)	깊이조절 (Depth control)	○	○
	탈부착(Detachable)	○	-
	스펀지(Sponge)	고밀도 성형 스펀지(High-density molding foam)	고급 성형 스펀지(Premium Molding Foam)
캐스터(Caster)	60Φ 소프트 타입(60Φ Soft Type)	60Φ 소프트 타입(60Φ Soft Type)	
옵션(Additional Items)	가방걸이 / 코트행거(Bag hanger / Coat hanger)	-	

	BALANCE	ASCENT	T353G
			
제품 상세(Product Details)			
프레임 컬러(Frame Color)	● Black ○ White	● Black   ○ White   ○ Orange	● Black ○ White
등판 컬러(Backrest Color)	● Charcoal ● Light Gray	● Gray   ● Black   ● Orange	● Black ● Gray
좌판 컬러(Seat Color)	● Charcoal ● Light Gray	● Beige   ● Gray   ● Black   ● Orange	● GY   ● BE   ● BU   ● BK
상세 사이즈 (Dimensions)			
주요 기능(Key Features)			
틸팅 (Tilting)	싱크로나이즈 틸트 / 셀프텐션 틸트 (Synchro Tilt / Auto Tilt)	싱크로나이즈 틸트 / 셀프텐션 틸트 (Synchro Tilt / Auto Tilt)	싱크로나이즈 틸트 / 셀프텐션 틸트 (Synchro Tilt / Auto Tilt)
	○ 4단계(4-tiers)	○ 4단계(4-tiers)	○ 4단계(4-tiers)
	-	-	○
메쉬 (Mesh)	○	○	○
	-	-	-
	○	○	○
인조가죽 (Artificial Leather)	○	○	○
	-	-	-
	○	○	○
고급 성형 스펀지 (Premium Molding Foam)	○	○	○
	-	-	-
	○	○	○
캐스터(Caster)	60Φ 소프트 타입(60Φ Soft Type)	60Φ 소프트 타입(60Φ Soft Type)	60Φ 소프트 타입(60Φ Soft Type)
옵션(Additional Items)	-	-	-

# TECHNIC FLOW <sup>NEW</sup> 테크닉 플로우



더 쾌적한 착좌감을 제공하는 풀 메시 사양의 프리미엄 데스크 체어입니다. 통기성이 뛰어난 풀 메시 소재가 사용돼 장시간 앉아도 해먹같이 편안한 환경을 유지해주며, 인체공학적 디자인으로 편안한 자세를 지원합니다.

This is a premium desk chair featuring a full mesh design that provides enhanced comfort. The highly breathable full mesh material ensures a hammock-like comfort even after long hours of sitting, while the ergonomic design supports a comfortable posture.



1. 헤드, 등, 좌판 전체 프리미엄 메시 사양
2. 고탄성 원사로 구성된 좌판 전용 메시 개발로 스펀지처럼 편하고 쾌적한 착좌감
3. 기본 컬러부터 바라보는 방향에 따라 달라지는 유니크한 컬러까지 다양한 라인업
4. 기존 테크닉 체어와 메시 헤드레스트 호환 가능

1. Full premium mesh specifications for the headrest, backrest, and seat.
2. Dedicated mesh developed for the seat, made with highly elastic yarn, providing a comfortable and pleasant sitting experience like a sponge.
3. A diverse lineup, from basic colors to unique colors that change depending on the viewing angle.
4. Compatible with existing Technic Chairs and mesh headrests.



Color/Material			
프레임 FRAME	WH	BK	BK
등/좌판 BACK/ SEAT	WH	BK	BK
	GY / MESH	PU+BU / SHIFT MESH	GN+BU / SHIFT MESH
			BK / MESH

# TECHNIC 테크닉



책상 생활에 신체 부담을 줄여주는 기술력을 더한 맞춤형 의자입니다. 머리를 좌/우로 감싸주는 기능성 듀얼 헤드레스트로 편안한 착석감을 제공합니다.

It is a custom chair enhanced with technology that reduces physical strain during desk activities. It provides comfortable seating with a functional dual headrest that cradles the head from side to side



1. 높이, 깊이, 각도 조절 모두 가능한 2가지 타입의 헤드레스트
2. 요추 중심을 지지하는 55mm 두께의 스펀지 럼버 서포트
3. 눈슬립패드 적용된 코트헹거
4. 좌판 패드/좌판 패브릭 교체 가능

1. Two headrest options with fully adjustable height, depth, and angle.
2. Coat hanger with non-slip pad
3. 55mm thickness sponge applied to support lumbar
4. Seat pad/seat fabric can be exchanged



Color/Material				
등판 BACK	RE / MESH	BU / MESH	GN / MESH	BK / MESH
좌판 SEAT	RE / FABRIC	BU / FABRIC	GN / FABRIC	DG / FABRIC
				DG / FABRIC

# ARCO 아르코



업무 효율을 높일 수 있는 편안한 의자로 착석감을 고려한 맞춤형 의자입니다. 세계적인 디자이너의 유니크한 디자인으로 차별화된 스타일을 제공합니다.

A comfortable chair that can increase work efficiency and can be customized. Recommended for users who value a comfortable seating sense. Offers a differentiated style with the unique design of world-class designers.

Designed by Claudio Bellini



- 1 세계적인 이탈리아 산업 디자이너 클라우디오 벨리니의 유니크한 디자인
- 2 사용자의 체형에 맞춰 근육의 긴장과 피로를 줄여줄 수 있는 다양한 조절 기능
- 3 해먹에 기댄 것처럼 넓고 편안한 메시 헤드레스트

- 1 Unique design by a worldclass Italian industrial designer Claudio Bellini
- 2 Various control functions that can reduce muscle tension and fatigue according to the user's body
- 3 Wide and comfortable mesh headrest as if leaning in a hammock

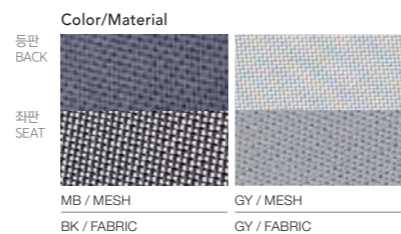

# T353G



탄성이 좋은 메쉬를 소재로 제품의 형태를 그대로 유지시켜주며, 화이트/블랙 프레임과 투톤 패브릭으로 고급스러운 컬러는 물론 따뜻하고 편안한 분위기를 연출해줍니다.

The highly elastic mesh keeps the shape of the product and you can choose the color white or black frame to match the atmosphere of the space. Two-tone fabric presents luxurious colors while also providing a warm and comfortable atmosphere.



### 셀프텐션형 틸트

- 1 틸트 강도 조절 : 사용자의 하중에 비례해서 자동으로 틸트 강도가 조절되지만, 틸트 강도를 조절할 수 있도록 3단계 강도조절 기능을 제공합니다. 의자 착석 시 오른쪽 레버를 회전시켜 조절합니다.
- 2 틸트 LOCK : 원하는 틸팅 각도에서 4단계 고정, 의자 틸팅 후 왼쪽 레버를 앞으로 돌려서 고정, 의자 등판을 밀면서 레버를 뒤쪽으로 돌려서 해제합니다.
- 3 의자 높낮이 조절 : 틸트의 우측 손잡이를 이용하여 의자 높낮이를 조절할 수 있습니다.

### Self Tension Tilt Type

- 1 Tilt Strength Adjustment : automatically adjusts the tilt intensity in proportion to the user's weight, but it also provides 3-step intensity adjustment function to allow users to adjust the tilt intensity according to the user's preference. Rotate the right lever to adjust when sitting on a chair.
- 2 Tilt LOCK : You can fix the desired tilt angle through 4 steps. After tilting the chair, turn the left lever to the front to fix it, push the chair backboard and turn the lever backward to release it.
- 3 Adjust the height of the chair: You can adjust the height of the chair as much as you want by using the right knob of the tilt under the seat.



# ASCENT PLUS NEW 어센트 플러스



베스트셀러 어센트 চে어에 팔걸이 조절 기능을 더해 내 몸에 꼭 맞게 조절할 수 있는 이지 테스크 চে어입니다. 사용자의 체형과 작업 환경에 맞춰 팔걸이 높이를 자유롭게 조절할 수 있어 편안함과 실용성을 동시에 갖춘 프리미엄 의자입니다. This is the Easy Task Chair, enhanced with adjustable armrests added to the bestselling Ascent Chair, allowing a perfect fit for your body. The armrest height can be freely adjusted to suit your body shape and work environment, providing both comfort and practicality in a premium chair.



1. 팔걸이 조절 기능으로 내 몸에 꼭 맞게 사용
2. 9단계 높이 조절 헤드레스트
3. 등받이와 좌판 각도가 다른 비율로 부드럽게 움직이는 싱크로나이즈드 틸팅
4. 최대 500mm의 높이와 총 5단계 깊이로 조절되는 좌판

1. Adjustable armrests for a perfect fit
2. 9-levels height adjustable headrest
3. Synchronized tilting where the backrest and seat angles move smoothly at different ratios
4. Seat adjustable to a maximum height of 500mm and a total of 5 depth levels



# ASCENT 어센트



핵심 기능과 리바트만의 고유 디자인으로 신체를 안정적으로 지지하고 자세를 유지시켜 주는 의자입니다. It provides stable support and maintains posture through its core functionality and unique design exclusive to LIVART.



1. 상하좌우 방향으로 머리 또는 목 위치에 맞춰 사용할 수 있습니다. (조절 범위 : 40mm, 9단계 조절 가능)
2. 아름다운 구조로 형성된 어센트만의 독특한 암 레스트 디자인입니다.
3. 브릿지 구조가 안정감을 제공하고, 사선 패턴이 단조로움을 줄여줍니다.
4. 인체공학적 고밀도 PU폼으로 안정적인 지지와 편안함을 제공합니다.

1. It allows for head or neck positioning in any direction—up, down, left, or right. (Adjustment range: 40mm, 9 levels of adjustment)
2. It is ASCENT's uniquely designed armrest, formed by a beautiful structure.
3. The bridge structure provides stability, and the diagonal pattern reduces monotony.
4. It offers stable support and comfort with ergonomic high-density PU foam.



### Color/Material

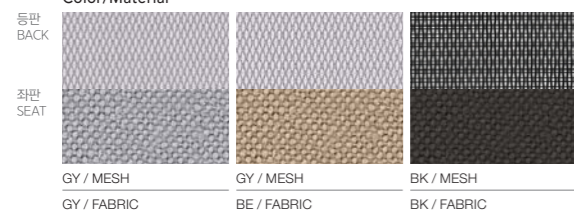

### Color/Material

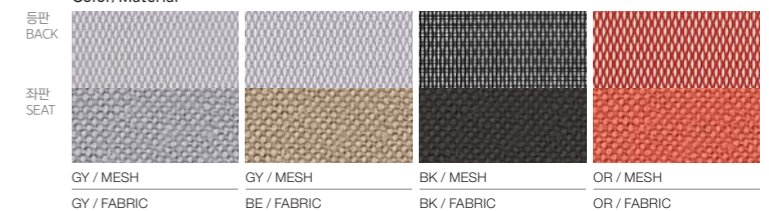

# BALANCE 밸런스



다양한 체형에 맞춰 사용 가능한 등받이 각도 조절  
기능과 넓고 편안한 메쉬 헤드레스트로 장시간의  
업무의 피로를 줄여주는 의자입니다.

A chair with its backrest recline function for  
various body types and wide, comfortable  
mesh headrest for a better rest, lessens your  
fatigue from hours of work.



- 1 넓은 면적으로 감싸주어 더욱 편안한 메쉬  
헤드레스트
- 2 사용자의 편의에 따라 원하는 각도로  
틸팅(등받이 기울기) 조절 가능
- 3 심플한 U형 프레임 디자인

1. A more comfortable mesh headrest with its  
wide embracing contact
2. Adjustable tilting angles for your  
convenience (backrest recline)
3. Simple U-frame design

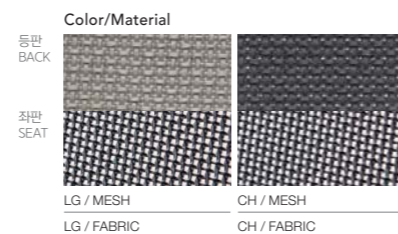

# NEW BOOST 뉴부스트



수많은 선택을 받은 부스트에서 모든 기능을 업그레이드 하여 완성된 데스크 체어입니다.

어떤 자세에서도 안정감 있고, 누구에게나 꼭 맞는 착석감을 갖춘 새로운 기준의 의자입니다.

This is a task chair perfected by fully upgrading all features of the highly popular Boost.

It sets a new standard as a chair that offers stability in any posture and a seating experience tailored to everyone.



1. 헤드레스트 높낮이/각도 조절 기능  
\* 높낮이 : 총 60mm 13단계 조절
2. 우수한 복원성의 고탄성 메시, 인체 공학적 설계 프레임 적용
3. 허리를 감싸는 서라운드 램버서포트

1. Headrest Height and Angle Adjustment  
\* Height: 13-step adjustment over a total range of 60mm
2. High-elasticity mesh with excellent resilience,  
combined with an ergonomically designed frame
3. Surround lumbar support that wraps around the lower back



# MULTI-USE

Get Inspired with Movement

심플하고 완벽하게, 어디서든 다양한 영감을 일으키는 리바트 다목적 의자



## MULTI-USE CHAIR 공용 의자

### mauve 모브



스위블 타입 Swivel Type  
Finish. PLASTIC+FABRIC  
Color. WH / BE / GN / BK

W585 D520 H785-840



4LEG 타입 4LEG Type  
Finish. PLASTIC+FABRIC  
Color. WH / BE / GN / BK

W540 D540 H775



와이어 타입 Wire Type  
Finish. PLASTIC+FABRIC  
Color. WH / BE / GN / BK

W535 D540 H775



바스툴 타입 Bar Stool Type  
Finish. PLASTIC+FABRIC  
Color. WH / BE / GN / BK

W580 D562 H1035

### Vato 바토



일반형 General Type  
Finish. PLASTIC+FABRIC  
Color. BE / GN / DG

W580 D543 H872



반고정형 Semi-Fixed Type  
Finish. PLASTIC+FABRIC  
Color. BE / GN / DG

W580 D543 H872

### Union Variety 유니온 버라이어티



4LEG 기본형  
4LEG Standard Type  
Finish. PLASTIC  
Color. WH / DG / BR / GN

W520 D520 H880



4LEG 패브릭형  
4LEG Fabric Type  
Finish. PLASTIC+FABRIC  
Color. CB / LB / BR / PK / GN

W520 D520 H880



스위블 기본형  
Swivel Standard Type  
Finish. PLASTIC  
Color. WH / DG / BR / GN  
WH / BK (Frame)

W625 D560 H883-1003



스위블 패브릭형  
Swivel Fabric Type  
Finish. PLASTIC+FABRIC  
Color. CB / LB / BR / PK / GN  
WH / BK (Frame)

W625 D560 H883-1003

### SEMINAR 세미나



좌판 패딩형 Seat Pad Type  
Finish. FABRIC  
Color. GY / GN / TC / YE

W500 D560 H790



기본 타입 Standard Type  
Finish. FABRIC  
Color. GY / GN / TC / YE

W500 D560 H790

### JOEL 조엘



미들백 타입 Mid-Back Type  
Finish. MESH+FABRIC  
Color. BK / GY / RE

W650 D530 H910-980



기본 타입 Standard Type  
Finish. MESH+FABRIC  
Color. RE / BU / GN / GY

W534 D515 H837  
\* 팔걸이, 팔경대 옵션 추가 가능

### GRAB 그랩



팔걸이형 Armrest Type  
Finish. MESH+FABRIC  
Color. WH / CBR/ BK (MESH)  
BE / GY / CBR / DG (FABRIC)

W595 D610 H900



일반형 General Type  
Finish. MESH+FABRIC  
Color. WH / CBR/ BK (MESH)  
BE / GY / CBR / DG (FABRIC)

W520 D610 H900

### RIFF 리프



암체어 타입 Armchair Type  
Finish. FABRIC  
Color. GY / DG / MS

W530 D620 H770

### PRONTO 프론토



기본 타입 Standard Type  
Finish. MESH+FABRIC  
Color. BK

W630 D450 H810

### FIT 핏



기본 타입 Standard Type  
Finish. PLASTIC  
Color. BK / WH

W460 D517 H853

### ACC - COMFY 콤피



패딩형 PADDING TYPE  
Finish. FABRIC  
Color. GY / DG / BR

465 · 325 · 320



- 1 수직 적층이 가능하여 공간 활용을 극대화합니다.
- 2 Daivs社의 마감재의 고품질 패브릭으로 높은 퀄리티를 구성합니다.
- 3 인간 공학적으로 설계된 유선형 좌판으로 편안한 착석감을 제공합니다.

- 1 It allows for vertical stacking, maximizing space utilization.
- 2 The use of high-quality fabrics for the finishes by Davis Co. further enhances the high quality of the product.
- 3 The ergonomically designed streamlined seat provides a comfortable seating experience.

\*좌고높이 : 440mm (Wire Type)  
\*패딩사양 : +20mm

	Color/Material			
등판 BACK				
좌판 SEAT				
	WH / MAIN SHELL	BE / MAIN SHELL	GN / MAIN SHELL	BK / MAIN SHELL
	BE / FABRIC	BE / FABRIC	GY / FABRIC	BK / FABRIC



- 1 패브릭 커버를 통해 고급스러운 마감 프리미엄을 보여줍니다.
- 2 방수 패브릭 커버는 오염에 강하고 쉽게 교체 가능합니다.
- 3 인체 형상에 맞춘 메인셸 디자인으로 균일한 착석감을 제공합니다.







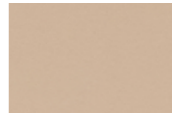

- 1 The fabric cover showcases a luxurious premium finish.
- 2 The waterproof fabric cover is resistant to stains and easily replaceable.
- 3 The main shell design tailored to the human body shape provides a uniform seating experience.

Designed by  
Jeff Weber 

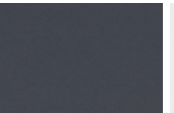
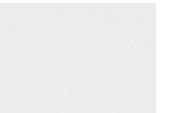
 GOOD DESIGN FURNITURE 2022 WINNER

 red dot winner 2022

 BIFMA INTERNATIONAL MEMBER

Color/Material			
			
기본형 Standard Type			
BR / PLASTIC	GN / PLASTIC	DG / PLASTIC	WH / PLASTIC
			
패브릭형 Fabric Type			
CB / FABRIC	GN / FABRIC	PK / FABRIC	LB / FABRIC
			
			BR / FABRIC



1. 핸들 일체형 디자인으로 손쉬운 이동
2. 특허 출원한 메시 손상 방지 기능 (메시와 프레임 사이 버퍼 적용)  
\* 엘라스토머 버퍼 : 책상 모서리와의 충격 완화
3. 틸팅방식, 고탄성 스폰지 좌판으로 편안한 착석감
4. 좌판 폴딩 시 수평 적층 가능토록 설계

1. Integrated handle design for easy mobility
2. Patented mesh damage prevention feature (Apply buffer between mesh and frame)  
\* Elastomer Buffer : Impact protection at the corners of the desk
3. Tilting mechanism with high-resilience sponge seat for comfortable seating
4. Designed for horizontal stacking when the seat is folded



Color/Material			
등판 BACK			
좌판 SEAT			
	WH / MESH	CBR / MESH	BK / MESH
	BE / FABRIC	CBR / FABRIC	DG / FABRIC



- 1 의자를 폴딩하여 공간 활용과 보관이 간편한 구조입니다.
- 2 몸을 쫓힐 때 등판이 틸팅되어 장시간 사용에도 편안한 백틸링 기능을 갖췄습니다.
- 3 볼캐스터와 글라이더 조합으로 부드러운 이동과 안정적인 고정 가능합니다.

- 1 It allows for vertical stacking, maximizing space utilization.
- 2 The use of high-quality fabrics for the finishes by Davis Co. further enhances the high quality of the product.
- 3 The combination of casters and gliders allows for smooth movement and stable positioning.

Color/Material		
프레임 FRAME		
좌판 SEAT		
	WH / MAIN SHELL	BK / MAIN SHELL
	BE / FABRIC	DG / FABRIC

# SEMINAR 세미나



- 1 착석자의 몸무게에 따라 틸팅 강도가 자동으로 세팅되는 체중 감응형 틸팅을 적용하여 편안한 착석감을 제공합니다.
  - 2 의자를 적층하여 보관할 수 있어 공간 활용이 용이하며 이동형 카트(옵션) 사용시 더 많은 의자를 보관, 이동하기에 편리합니다. (이동형 카트 : 최대 10개 적층 권장)
  - 3 마모방지 기능이 있는 글라이드를 적용하여 손상, 소음 없이 제품을 이동시킬 수 있습니다.
- 1 By applying weight sensitive tilting which automatically set its tilting strength, the comfortable seating can be provided to the user.
  - 2 Chairs can be stacked for easy storage, and more chairs can be stored and convenient to move when using an optional mobile cart. (Mobile cart: recommended stacking up to 10)
  - 3 Glide with anti-wear function can move the product without damage or noise.

\* 좌고높이 : 445mm

#### Color/Material

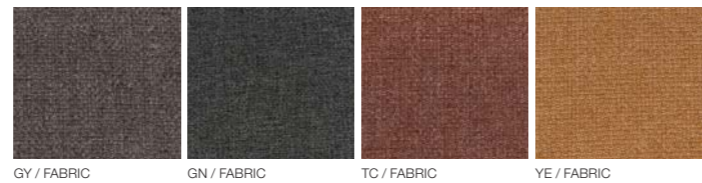

# JOEL 조엘



- 1 하중에 비례해 자동으로 강도가 조절되는 셀프텐션 싱크로나이즈 틸트
  - 2 체형에 맞게 조절 가능한 요추 지지대
- 1 A Self-tension synchronized tilt sets its tension in proportion of weight automatically
  - 2 Lumbar support that can be adjusted depending on the body type



#### Color/Material



# MEDITIO 메디오

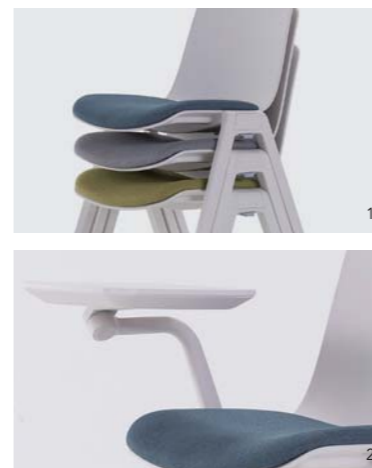

- 1 협소한 공간에서 보관이 가능한 수직 적층 구조
  - 2 필경대 옵션
- 1 Can be stacked to reduce space in narrow areas
  - 2 Option : Side Table



#### Color/Material

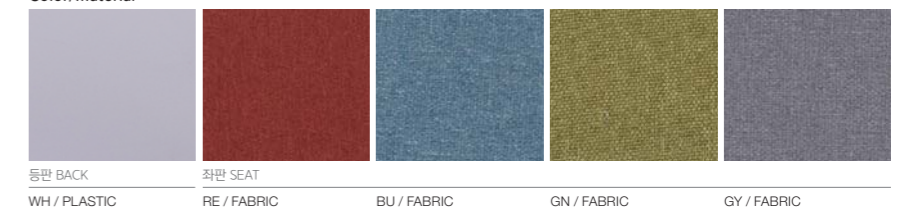

\* 좌고높이 : 450mm

# RIFF 리프



- 1 4.5cm의 좌판 패딩으로 풍성한 편안함을 느낄 수 있습니다.
- 2 일체형 등좌판으로 착석시 더 밀착된 착좌감을 제공합니다.
- 3 의자를 적층하여 보관할 수 있어 공간 활용이 용이합니다.

- 1 Rich comfort can be felt with 4.5cm thick seat padding.
- 2 Integrated back and seat provide a snug seating experience.
- 3 Chairs can be stacked for easy storage, maximizing space utilization

\* 좌고높이 : 440mm

### Color/Material

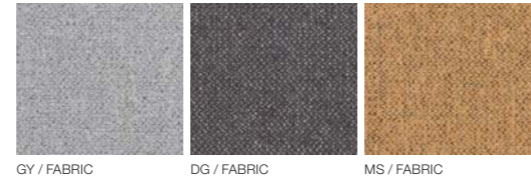

GY / FABRIC DG / FABRIC MS / FABRIC

# FIT 핏



편안하게 몸을 감싸는 곡면 형상으로 슬림하고 일체감 있는 디자인  
A curved shape that comfortably envelops the body. A slim and cohesive design with folding functionality for convenient storage.

\* 좌고높이 : 470mm



### Color/Material



BK / PLASTIC WH / PLASTIC

# PRONTO 프론토



부피를 줄여 보관이 용이한 폴딩기능  
Folding functionality for convenient storage to reduce volume

\* 좌고높이 : 440mm



### Color/Material



BK / MESH BK / FABRIC

# Comfy 콤피



- 1 2단구조로 업무 집중, 휴식시에 안정감과 편안함을 느낄 수 있습니다.
- 2 폭신한 사용감의 고탄성 릴렉스 패드
- 3 워터폴 디자인의 릴렉스 패드는 발목을 고르게 받쳐 줍니다.
- 4 하단의 완만한 각도 설계는 미끄러움을 방지해줍니다.

- 1 2-tier structure allows users to feel stable and comfortable when focusing on work and relaxing.
- 2 Highly elastic Relax Pad with a fluffy user experience
- 3 The waterfall design of the Relax Pad supports the user's ankles evenly.
- 4 Gentle angle design at the bottom prevents slipping.

\* 높이 : 1단 55mm / 2단 320mm



# Office PUBLIC

## AMENITY



GROOB 188



Palette 192



OH-HA 200

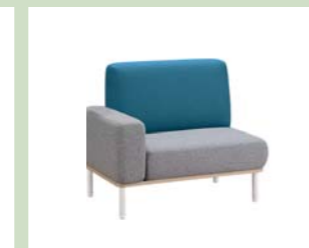

C600 Group 206

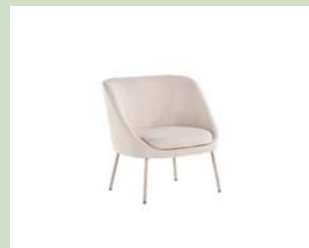

maas 216



nut 222



RS2 201 Group 228



RS1 100 Group 230



Phone-Booth 234

## SOFA



EX900 Group 238



Bake 238



RS7 700 Group 239

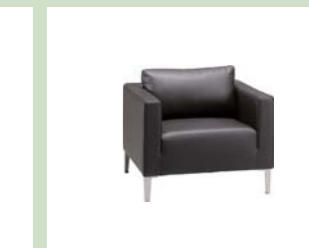

RS7 701 Group 239



Hermoso 240



Nieve 240



3200 Group 241



RS3 300 Group 241

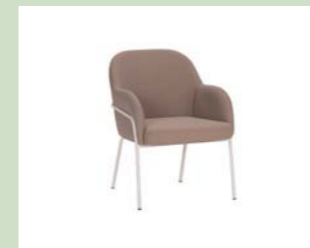

Mocha 242



LH 200 Group 242

## AMENITY TABLE



Sofa Table(Low-Height) 243



Sofa Table(Mid-Height) 244



Color-Base Table 244



Wood Table 244



Multi-Purpose Table 245



HAWORTH 246

## Lounge Layout

### 휴게라운지 15PY Community Lounge 15PY

휴게라운지는 휴식과 회복을 지원하는 리프레시 공간입니다. 아늑한 소파와 다양한 좌석의 구성으로 간단한 소통이나 개인 휴식 등의 유연한 활용이 가능합니다.  
Community Lounge is a refresh space designed to support rest and recovery. Cozy sofas and a variety of seating options allow for flexible use, such as simple interactions or personal breaks.

### 중형 커뮤니티존 Medium Community zone



Floor Plan

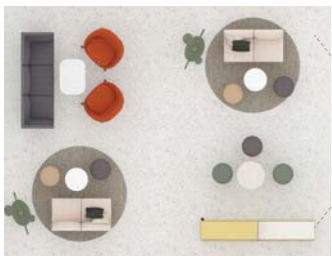

Perspective View



## Lounge Layout

### 휴게라운지 10PY Community Lounge 10PY

5~6인용 소파 배치는 자유로운 소통을 돕고, 라운지의 중심 축으로 공간 활용을 높여줍니다. 하이백 소파를 활용해 오픈된 공간에서도 자연스럽게 시각적·심리적 구분이 가능해, 여유와 집중을 모두 만족시키는 라운지 구성입니다.  
The arrangement of a sofa for 5 to 6 people facilitates free communication and enhances space utilization as the central axis of the lounge. By utilizing high-back sofas, it allows for natural visual and psychological separation even in open spaces, creating a lounge setup that satisfies both relaxation and focus.

### 중형 커뮤니티존 Medium Community zone



Floor Plan

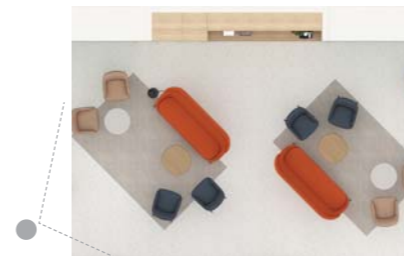

Perspective View



## Lounge Layout

### 휴게 라운지 10PY Canteen Lounge 10PY

휴게라운지는 직원들이 휴식을 취하고 소셜 네트워킹을 할 수 있는 공간의 기능을 갖춥니다. 직원들 간의 우연한 만남을 유도하고, 스몰토크로 영감을 일으키는 생산성 향상으로 이어지는 부드러우면서도 캐주얼한 분위기의 공간입니다.

Canteen Lounge is designed as a space where employees can relax and engage in social networking. It fosters an atmosphere that is both gentle and casual, conducive to spontaneous interactions among employees, and promotes productivity through inspiring small talk.



Floor Plan



Perspective View



## Lounge Layout

### 휴게 라운지 20PY Canteen Lounge 20PY

휴게라운지는 직원들의 업무에 대한 스트레스를 해소해 줍니다.

혼자만의 케렌시아를 느낄 수 있는 공간과 직원들과의 티타임을 즐기며 휴식을 즐길 수 있는 공간으로 배려합니다.

Canteen Lounge provides a space that helps relieve work-related stress for employees. It is designed to allow for moments of solitude, where one can experience their own "querencia," as well as areas for enjoying tea time and relaxation with colleagues.



Floor Plan

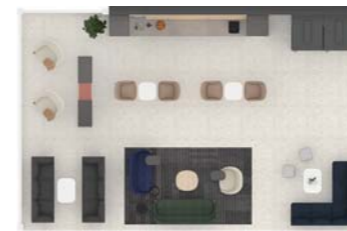

Perspective View



## Lounge Layout

### 워크라운지 5PY Work Lounge 5PY

미디어룸 레이아웃은 아이디어 회의, 프레젠테이션, 브리핑 등 다양한 업무 상황에 최적화되어 있으며, 화면을 중심으로 의견을 나눌 수 있어 효율적인 커뮤니케이션이 가능합니다. 팀워크를 강화하고 아이디어를 시각적으로 공유할 수 있는, 몰입형 워크 라운지입니다. The media room layout is optimized for various work situations such as idea meetings, presentations, and briefings, allowing for efficient communication centered around the screen. It is an immersive work lounge that enhances teamwork and enables visual sharing of ideas.

### 미디어 룸 (Media Room)



Floor Plan



Perspective View



## Lounge Layout

### 워크라운지 10PY Work Lounge 10PY

오픈된 공간에서 빠르게 모여 브레인스토밍이나 기획 회의를 할 수 있는 구성입니다. 높이가 다른 바 테이블과 일반 테이블을 함께 배치해 다양한 방식의 소통이 가능하며, 유연하고 창의적인 협업을 지원합니다. This setup allows for quick gatherings for brainstorming or planning meetings in an open space. By arranging bar tables of varying heights alongside regular tables, it enables diverse modes of communication and supports flexible and creative collaboration.

### 브레인스토밍 공간 Brain Storming



Floor Plan



Perspective View



## Lounge Layout

### 워크 라운지 20PY Work Lounge 20PY

워크라운지는 협업과 소통이 자연스럽게 촉진되는 공간입니다. 창가 공간을 활용한 간단한 퀵미팅 공간으로 캐주얼한 분위기에서의 업무 생산성을 높여줍니다. 또한, 개인적인 업무처리를 위한 세심함으로 편리성을 높입니다. Work Lounge is a space where collaboration and communication are naturally encouraged. Utilizing the window area as a quick meeting space enhances work productivity in a casual atmosphere. Additionally, it provides convenience with a focus on individual work processing.



Floor Plan



Perspective View



## Lounge Layout

### 워크 라운지 25PY Work Lounge 25PY

워크라운지는 업무와 협업, 휴게의 경계가 사라지는 공간입니다. 직원 간의 소통을 통해 서로 영감을 공유하는 공간이 되도록 디자인합니다. 개인 집중을 위한 포커스존과 휴식과 회의존이 따로 구분되지 않고 편의에 맞게 사용하도록 구성합니다. Work Lounge is a space where the boundaries between work, collaboration, and relaxation disappear. It is designed as a space for employees to share inspiration through communication. The focus zone for individual concentration and the zone for rest and meetings are not separated but are arranged to be used according to convenience.



Floor Plan

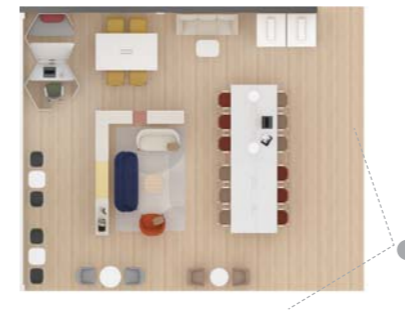

Perspective View



# GROOB 그루브 <sup>NEW</sup>

The GROOB lounge series that serves as the starting point of a space.

## 공간의 시작점이 되는 라운지 '그루브' 시리즈

로비와 워크 라운지 공간을 자연스럽게 연결해주는 모듈형 라운지 제품입니다. 다양한 구성 옵션을 제공하여 유연하게 연결된 곡선형 레이아웃 배치가 가능합니다. This is a modular lounge product that seamlessly connects lobby and work lounge spaces. It offers a variety of configuration options, enabling flexible, organically connected curved layout arrangements.



# GROOB



1. 소파는 인조가죽과 패브릭 콤비 2 타입과 전체 패브릭 2 타입으로 총 4가지 마감 옵션을 선택할 수 있습니다.
2. 소파와 선반은 동심원 설계로 소파 바로 뒤에 선반을 설치할 수 있습니다.
3. 선반을 길게 연장하여 소파와 함께 큰 라운지 영역을 만들 수 있습니다.
4. 패브릭 사양은 더블 파이핑 마감을 사용하고, 인조가죽 사양은 더블 스티치 마감을 적용했습니다.
5. 소파의 등받이 기둥은 소파마다 하나씩 적용되며, 시각적인 포인트를 제공합니다.

1. The sofa is available in four upholstery options: two types combining faux leather and fabric, and two types made entirely of fabric.
2. The sofa and shelf are designed with a concentric layout, allowing the shelf to be installed directly behind the sofa.
3. The shelf can be extended in length to create a larger lounge area together with the sofa.
4. The fabric option features a double piping finish, while the faux leather option uses a double-stitched finish.
5. Each sofa includes a backrest post, adding a distinct visual accent.

## SOFA 소파



**소형 등받이 소파 Small Backrest Sofa**  
Color. PB / SG / BS / MG  
2450 · 1210 · 690 (SH480)



**중형 등받이 소파 Medium Backrest Sofa**  
Color. PB / SG / BS / MG  
2540 · 1655 · 690 (SH480)  
\*좌/우 운영



**중형 소파 Medium Sofa**  
Color. PB / SG / BS / MG  
2240 · 1355 · 480



**대형 C타입 등받이 소파 Large C-type Backrest Sofa**  
Color. PB / SG / BS / MG  
2450 · 2100 · 690 (SH480)



**대형 C타입 소파 Large C-type Sofa**  
Color. PB / SG / BS / MG  
2240 · 1800 · 480



**대형 S타입 등받이 소파 Large S-type Backrest Sofa**  
Color. PB / SG / BS / MG  
3750 · 1400 · 690 (SH480)  
\*좌/우 운영



**대형 S타입 소파 Large S-type Sofa**  
Color. PB / SG / BS / MG  
3500 · 1050 · 480  
\*좌/우 운영

Color/Material			
등받이 BACK			
좌판 SEAT			
[PB]	[SG]	[BS]	[MG]
OT / FABRIC	BG / FABRIC	GY / FABRIC	BE / FABRIC
CM / LEATHER	BK / LEATHER	DG / FABRIC	GN / FABRIC

## SHELF 선반



**3단 커브형 선반 (좌/우) 3-tier Curved Shelf (L/R)**  
Color. GRG+SBK / NW+SBK / NW+SUS  
1317 · 500 · 790  
\*좌/우 운영



**3단 커브형 선반 (센터) 3-tier Curved Shelf (Center)**  
Color. GRG+SBK / NW+SBK / NW+SUS  
1317 · 500 · 790



**3단 직선형 선반 3-tier Straight Shelf**  
Color. GRG+SBK / NW+SBK / NW+SUS  
1200 · 400 · 790



**4단 커브형 선반 (좌/우) 4-tier Curved Shelf (L/R)**  
Color. GRG+SBK / NW+SBK / NW+SUS  
1317 · 500 · 1165  
\*좌/우 운영



**4단 커브형 선반 (센터) 4-tier Curved Shelf (Center)**  
Color. GRG+SBK / NW+SBK / NW+SUS  
1317 · 500 · 1165



**4단 직선형 선반 4-tier Straight Shelf**  
Color. GRG+SBK / NW+SBK / NW+SUS  
1200 · 400 · 1165



**연결 브라켓 Connection Bracket**  
Color. SBK  
66 · 66 · 3  
\* 3단용(2EA)/4단용(3EA) 운영

Shelf		Pillar	
GRG / LPM	NW / LPM	SBK / STEEL	SUS / STEEL

# Palette 팔레트



Create an office space with a vibrant palette of colors and modules

생기 있는 컬러와 모듈의 팔레트로 그리는 오피스 공간

생각이 모여 새로운 성과가 되고, 다양한 컬러와 모듈이 모여 공간의 가치를 만듭니다. 팔레트에서 유연한 생각과 다채로운 아이디어를 설계하세요.

Ideas come together to create new solutions, while colors and modules come together to create value in user's space.



캐빈존 : 캐빈 정수기장, W1200 캐빈 높은 수납장 세트(거울형), W800 캐빈 높은 수납장 세트(분리수거형), 캐빈 키큰장  
소파존 : W1200 3단장, W1200 4단장, 익스텐션 박스, 미니 수납 박스(옵션), 구조 박스 뒷판(옵션), 원형 스크린 보드

**수납과 공간 구획이 동시에 가능한 다채로운 공간 솔루션**

시스템장, 수납장으로 공간의 개념을 확장하여 다양한 아이디어를 확장할 수 있습니다.  
 집중이 필요한 사무 공간부터 아이디어가 필요한 라운지 공간까지 공간이 주는 긍정적인 효과를 경험해보세요.



W1200 3단장, W1200 4단장, 익스텐션 박스, 미니 수납 박스(옵션), 구조 박스 뒷판(옵션), 원형 스크린 보드

1 회의공간  
 경직된 회의 공간에서 다양한 아이디어가 나올 수 있는 유연한 공간으로 전환하고, 외부의 시선을 차단해 집중도를 높여 줍니다.

1 Conference Rooms  
 Transform rigid conference rooms into flexible space that allows for a variety of ideas to emerge as well as while transforming open spaces into private spaces by blocking the views from the outside to enhance concentration.



캔틴 정수기장, 캔틴 냉장고장, W1200 캔틴 높은 수납장 세트(거울형), W1200 캔틴 높은 수납장 세트(선반형/분리수거형), 캔틴 키큰장

2 캔틴 · 카페 공간  
 별도의 시공 없이 연출 가능한 캔틴·카페장 인테리어로 애자일(Agile)한 조직에 필요한 커뮤니티 공간을 제안합니다. 여기에 바 조명과 거울로 활력 있는 분위기를 더할 수 있습니다.

2 Canteens & Cafes  
 Allows to design of the space suitable to be used as canteens and cafes without any constructions to serve as a community space in an agile organization. Bar lighting and mirrors are added to create an energetic atmosphere.

**Colorful space solutions with both storage and space zoning features.**

Expand the concept of space with System Cabinets and Drawers to create new ideas. Experience the benefits given by the space in offices and lounges, where concentration is needed to create new ideas



\* 캔틴 정수기장, W1200 캔틴 높은 수납장 세트(거울형), W800 캔틴 높은 수납장 세트(분리수거형), 캔틴 키큰장  
 \* W1200 3단장, W1200 4단장, 익스텐션 박스, 미니 수납 박스(옵션), 구조 박스 뒷판(옵션), 원형 스크린 보드

3 공용 · 라운지 공간  
 집중과 휴식을 함께할 수 있는 확장된 개념의 라운지 공간을 연출해줍니다. 프레임장은 장식장 또는 파티션으로 역할을 더하여 공간 활용을 극대화하였습니다.

3 Communal Lounges  
 It creates an advanced concept of a lounge where concentration and relaxation can be done together. The Frame Storage maximizes the use of space by acting as a decorative cabinet or partition.



W1200 3단장, W1200 4단장, W800 하부장, W800 3단장

4 업무 공간  
 업무에 대한 집중을 극대화하며 활력을 주는 컬러 바리에이션에 수납 기능까지 더했습니다. 잘 정리된 업무 공간은 업무에 대한 효율을 증가시켜줍니다.

4 Workspaces  
 Maximized concentration level and boosts energy with color variants with storage features. A well-organized workspace increases user's efficiency.



W1200 3단장, W1200 4단장, 익스텐션 박스, 미니 수납 박스(옵션), 구조 박스 뒷판(옵션), 원형 스크린 보드



- 1 프레임이 안정적으로 지지 해주는 박스 구조로 2번째 단 위치해야 합니다.
- 2 원하는 컬러 옵션 뒷판 추가하여 폐쇄형 구조가 가능합니다.(옵션)  
\* 구조 박스에만 결합, 원하는 컬러 조합(SBK, LG, YE) 가능
- 3 익스텐션 박스를 통한 프레임 간 자유로운 연결 및 확장, 다양한 컬러 조합 구성이 가능합니다.  
(프레임, 구조선반, 뒷판, 익스텐션 박스의 컬러 조합)
- 4 보드마카로 필기할 수 있는 원형 스크린 보드와 펜 등을 수납할 수 있는 펜트레이(옵션)
- 5 프레임 구획을 나누고 수납을 도와주는 미니 옵션 박스(옵션)  
\* 2컬러(LG, YE) 운영, 비고정형
- 6 프레임장 형태에 수납 중심의 하부장으로 프레임장과 동일 컬러 조합

- 1 It stably supports the frame, which should be located on the 2nd floor.
- 2 Backboard, with a color of user's preference, can be added to make it enclosed  
\*Can only be attached to Structure Boxes, Available color combinations (SBK, LG, YE)
- 3 Extension boxes allow connection and expansion between frames and various color combinations are available. (Color combinations of Frame, Structure Shelf, Backplate, Extension Box)
- 4 Round screen board that can be used to write with felt pens and pen tray to hold pens (Sold separately)
- 5 Mini Option Boxes to divide frame compartments and to store (Sold separately)  
\*2 color combinations (LG, YE), Not fixed
- 6 An Under-the-Desk Side Cabinet in the shape of a Frame Storage with the same color as the Frame Storages



\* 캔틴 정수기장, 캔틴 냉장고장, W1200 캔틴 높은 수납장 세트(거울형), W1200 캔틴 높은 수납장 세트(선반형/분리수거형), 캔틴 키큰장  
\* W1200 3단장, W1200 4단장, 익스텐션 박스, 미니 수납 박스(옵션)



기본 타입 General Type

분리수거 도어 스티커 부착 예시  
Example of attaching a door sticker for recycling

- 1 캔틴장 상판은 구성에 따라 별도 운영합니다.(별도 주문 필수)
- 2 높은 수납장 사용시 선반 포함으로 캔틴장의 효율적인 사용을 도와줍니다.  
\* 선반형 선반 2EA / 거울형 선반 1EA
- 3 뒷 판넬과 결합되는 타공판과 철제 선반은 포인트 컬러는 물론 다양한 활용을 제공합니다  
\* W1200 선반형 캔틴 주문 시 타공판 좌우 부착 선택 가능
- 4 캔틴장내에는 일반 조명과 거울형 조명을 옵션으로 구성할 수 있습니다.  
조명 사용시(거울형 포함) 조명 전원(어댑터)을 별도로 필수 추가 주문해야합니다.
- 5 분리 수거 도어 주문시 스티커 동봉으로 고객 직접 부착이 필요합니다.

- 1 Canteen Storage Top Boards are sold separately depending on configuration (Must be ordered separately)
- 2 Shelves can be added when cabinets are used high to help users to use Canteen Storages more efficiently.  
\* 2EA Shelf-type Shelves / 1EA Mirror-type Shelf
- 3 The perforated board can be combined with the back panel, and steel shelves offer versatility as well as eye-catching colors.  
\*You can choose to attach a perforated board left or right upon ordering a W1200 Shelf-type Canteen.
- 4 The canteen can be optionally configured with general lighting and mirror lighting.  
When using lighting (including mirror lighting), you must order a lighting power (adapter) separately.
- 5 Stickers are included in doors for recycling cabinets, which users need to apply themselves.

# Palette

## Frame Storage 프레임장



W800 3단장 W800 3-tiered Storage  
Color. SBK / SW / YE  
800 · 420 · 1160



W1200 3단장 W1200 3-tiered Storage  
Color. SBK / SW / YE  
1200 · 420 · 1160



W800 하부장 Under-the-Desk Side Cabinet  
Color. SBK / SW / YE  
800 · 420 · 1160



W800 4단장 W800 4-tiered Storage  
Color. SBK / SW / YE  
800 · 420 · 1531



W1200 4단장 W1200 4-tiered Storage  
Color. SBK / SW / YE  
1200 · 420 · 1531



원형 스크린 보드 Round Screen Board  
Color. LG  
1093 · 1093 · 15  
\* 4단장만 호환 가능



익스텐션 박스  
Extension Box  
Color. YE / SW / TC  
1159 · 397 · 350



구조 박스 뒷판(옵션)  
Structure Box Backplate (Optional)  
Color. SBK / SW / YE  
W800 프레임용 For W800 Frame  
760 · 353 · 15  
W1200 프레임용 For W1200 Frame  
1160 · 353 · 15



미니 수납 박스(옵션)  
Mini Storage Box (Optional)  
Color. SW / YE  
350 · 379 · 350



행잉 팬트레이 Hanging Pen Tray  
Color. YE  
60 · 92 · 110



# Palette

## Canteen Storage 캐넌장

\* 분리수거형 주문 시, 스티커 동봉(스티커 고객 직접 부착)  
\* 캐넌장 주문 시 마감 상판 주문 필수



분리수거형 Recycling Type  
W800 캐넌 낮은 수납장 세트  
W800 Low Canteen Storage Set  
일반형/분리수거형 General Type/Recycling Type  
Color. SW / SBK  
800 · 640 · 910



분리수거형 Recycling Type  
W1200 캐넌 낮은 수납장 세트  
W1200 Low Canteen Storage Set  
일반형/분리수거형 General Type/Recycling Type  
Color. SW / SBK  
1200 · 640 · 910



캐넌장 마감 상판  
Canteen Storage Top Board  
Color. SG  
800/1200/1600/2000/2400 · 620 · 15



분리수거형 Recycling Type  
W800 캐넌 높은 수납장 세트  
W800 High Canteen Storage Set  
일반형/분리수거형 General Type/Recycling Type  
Color. SW / SBK  
800 · 640 · 1904



분리수거형 Recycling Type  
W1200 캐넌 높은 수납장 세트(선반형)  
W1200 High Canteen Storage Set (Shelf-type)  
일반형/분리수거형 General Type/Recycling Type  
Color. SW / SBK  
1200 · 640 · 1904



분리수거형 Recycling Type  
W1200 캐넌 높은 수납장 세트(거울형)  
W1200 High Canteen Storage Set (Mirror-type)  
일반형/분리수거형 General Type/Recycling Type  
Color. SW / SBK  
1200 · 640 · 1904(거울 ø460)  
\* 타공판, 액세서리 선반 미포함  
\* 조명 전원 별도 주문 필수



캐넌 정수기장 Canteen Water Purifier Storage  
Color. SW / SBK  
600 · 640 · 1904



캐넌 냉장고장 Canteen Refrigerator Storage  
Color. SW / SBK  
659 · 640 · 1904



캐넌 키큰장 Canteen Long Storage  
Color. SW / SBK  
600 · 640 · 1904



캐넌장 타공판 액세서리 선반  
Accessory Shelf for Perforated Board  
Color. SW / TC  
301 · 95 · 24  
\* 제품 한 개 주문 시, 2EA 포함

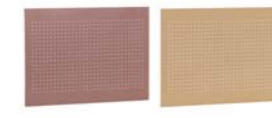

캐넌장 부착 타공판  
Canteen Storage Attachable Peg Board  
Color. YE / TC  
W800 부착용 W800 Compatible  
800 · 505 · 16  
W1200 부착용 W1200 Compatible  
700 · 505 · 16

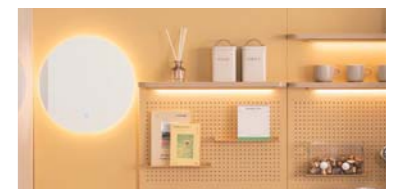

조명 (캐넌장 선반/원형) + 조명 전원  
Lighting(Canteen Shelf/Round) + Power Box  
\* 조명 W600 1EA 포함 / 조명 W1000 2EA 포함  
\* 조명 전원 1EA당 4개의 조명 연결 가능  
\* 전원 필수 주문

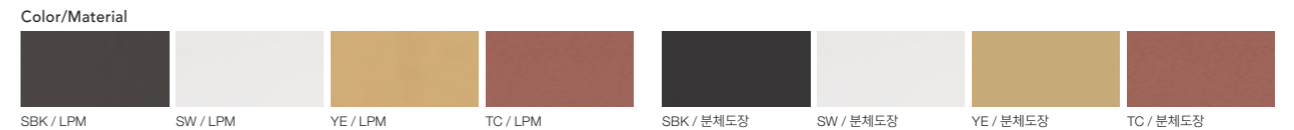

# OH-HA 오아



A space to gather, share, and grow—OH-HA

모이고, 나누고, 발전하는 공간. '오아'

다양한 사이즈와 컬러로 작은 공간부터 라운지 공간까지 폭 넓게 사용 가능한 시리즈입니다. 편안한 사용성과 위트있는 디자인으로 공간을 풍성하게 연출할 수 있습니다.

It's a series that can be used in a wide range of spaces, from small areas to lounges, available in various sizes and colors. It enriches the space with comfortable usability and a witty design.



파티션, 원형테이블, 돌 원형테이블, 스톤, 돌 스톤



### 휴게 공간 Relaxation Area

다 같이 모여서 자유로운 소통을 통해 각자의 가치관을 나눌 수 있는 공간  
 A space where everyone can gather to freely communicate and share their individual values



### 개인 휴식 공간 Personal Rest Area

편안한 분위기 속 창의적이고 특별하게 만들어주는 공간  
 A space that creates a comfortable atmosphere that is creative and uniquely special



### 아이디어 룸 Idea Room

소규모 인원이 보관된 자료를 열람하며 아이디어를 얻을 수 있는 공간  
 A space where small groups can access stored materials to generate ideas.



### 소형 킥미팅 공간 Small Quick Meeting Space

업무 공간 주변에서 빠르게 모여 소통할 수 있는 공간  
 A space to quickly gather and communicate around the workspace



- 1 독자적인 다리 디자인과 컬러를 사용한 리바트 오피스만의 테이블입니다.
- 2 빗각 엣지 마감으로 날렵하고 세련된 느낌을 연출해줍니다.
- 3 선인장에서 영감을 받은 디자인 파티션은 프라이버시를 위한 용도로 사용 가능합니다. (H1500mm)
- 4 발수 코팅으로 오염 방지 및 내구성이 높고, 파이핑 마감으로 패브릭을 섬세하게 연결했습니다.

- 1 A table exclusive to LIVART Office, featuring a unique leg design and color.
- 2 A beveled edge finish gives it a sharp and sophisticated look.
- 3 The cactus-inspired design partition can be used for privacy purposes. (Height 1500mm)
- 4 Water-repellent coating for stain prevention and durability, with piping finish delicately connecting the fabric.

## OH-HA



**원형테이블 Round Table**  
Color. LG / PK / KH  
600 · 600 · 735



**톨 원형테이블 Tall Round Table**  
Color. LG / PK / KH  
600 · 600 · 845



**사이드 테이블 Side Table**  
Color. LG / PK / KH  
470 · 470 · 545



**스툴 Stool**  
Color. KH / PK / BE / DG  
430 · 430 · 425



**톨 스툴 Tall Stool**  
Color. KH / PK / BE / DG  
430 · 430 · 605



**파티션 Partition**  
Color. BE / PK / KH  
900 · 550 · 1507

## Signature 시그니처



**시그니처 원형테이블  
Signature Round Table**  
Color. KH / PK  
600 · 600 · 740



**시그니처 톨 원형테이블  
Signature Tall Round Table**  
Color. KH / PK  
600 · 600 · 850



**시그니처 사이드 테이블  
Signature Side Table**  
Color. KH / PK  
470 · 470 · 550

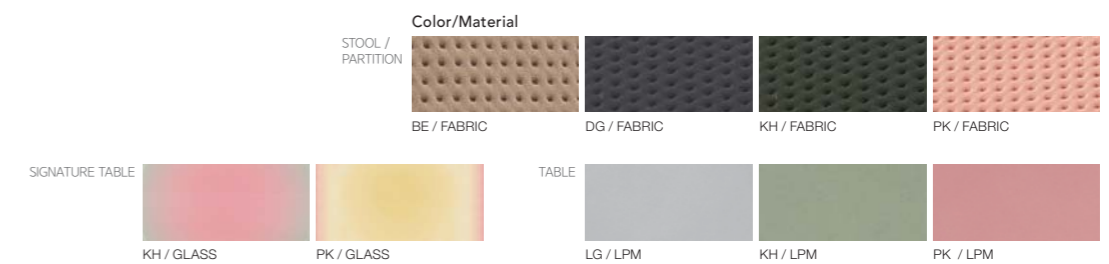

# C600 Group



Combination type common zone of new module

## 새로운 모듈의 조합형 공용존

구성원들의 업무성과를 높이기 위해 자연스러운 커뮤니케이션이 가능한 환경 조성이 가장 중요합니다. 홈 스타일로 보다 편안한 스마트 오피스를 제공해 드립니다.

Creating an environment, where members can easily communicate with each other to improve the work performance is important. We provide a comfortable smart office created with home style.



1인 라운드파티션 소파, 2인 라운드파티션 소파, 육각 라운드파티션 소파, 스톨형 라운드오픈 소파,  
등판형 라운드오픈 소파, 120도 파티션 데스크, 회의테이블, 소파테이블, 90도형 파티션, 120도형 파티션, 스탠딩 파티션, 스톨

## C600 Group Collaboration Space

경직된 분위기의 업무 스타일에서 벗어나 편안한 분위기에서 차 한잔을 마시며, 편안한 라운지에서 다양한 지원부서와의 다양한 커뮤니케이션을 위한 새로운 스마트 오피스 타입을 추천합니다.

Relax in a relaxed atmosphere, relax in a cozy lounge, we recommend a new smart office type for communication with various support departments in a comfortable lounge by drinking tea in a comfortable atmosphere, away from a strict atmosphere of work style.



모듈소파, 스톨소파, 티테이블

### 라운지 공간 Lounge Space

업무 공간 내에 라운지를 만들어 동료들과 정보를 손쉽게 공유할 수 있습니다.  
You can easily share information with colleagues by creating a lounge in your workspace.



사각스탠딩테이블, 바스툴



스탠딩테이블은 하부가림판으로 여성분들도 안심하고 앉을 수 있습니다.

Standing tables have the bottom cover plate and allow ladies to sit comfortably.

### 캐주얼한 회의 공간 Instant Meeting Space

작은 미팅 공간으로 간단한 업무 협의를 위한 효율적인 공간으로 활용하실 수 있습니다.  
You can use a small meeting space as an efficient space for simple business consultation.

## C600 Group Workshop Space

업무 공간과 가까운 공간에서 정식, 비정식 회의가 다양하게 이루어져 즉각적인 커뮤니케이션이 가능합니다. 스탠딩 파티션과 테이블, 소파 등을 활용하여 회의의 성격에 따른 공간으로 구성해보세요.

A variety of formal and informal meetings may be held in a space close to the workspace to enable immediate communication. Use standing partitions, tables and sofas to organize the space according to the characteristic of the meeting.



이동형 TV스탠드, 조합형회의테이블, 바스툴, 이지체어

### 정식 회의공간 Formal Meeting Space

스탠딩 파티션과 테이블로 앉아서도 서서도 일할 수 있는 회의 공간은 능률을 올려줍니다.  
Standing partitions and tables that allow you to sit or stand while working improve work efficiency.



스탠딩 파티션, 90도형 파티션, 120도형 파티션, 이동형TV스탠드, 회의테이블, 원형 스탠딩 테이블, 하이바스툴

### 중소 규모 미팅 공간 Casual Meeting Space

휴대폰, 노트북으로 시각적인 회의 자료를 활용, 공유하실 수 있습니다.  
You can utilize and share visual conference materials on your mobile phone or laptop.



(좌) 조합형 회의테이블, 이지제어, 낮은바스툴, 이동형 TV스탠드  
(우) 사각스탠딩테이블, 높은바스툴



- 1 이동형 TV 스탠드 전면 리모컨 거치대
  - 2 인조가죽소재의 커버 안쪽으로 케이블을 매립하여 깔끔한 배선처리가 가능합니다.
  - 3 라운드형 상판은 자유로운 회의 분위기를 조성하며 애쉬 원목 덕트 덮개는 세련된 느낌을 연출해줍니다.
- 1 Movable remote-control holder in the front of TV stand  
2 Cables can be embedded inside the cover of artificial leather material for neat wiring.  
3 The round-shaped top plate creates an unconstrained meeting atmosphere, and the wiring duct of the Ash wood gives a sophisticated feeling.

## C600 Group Focus Space

일자형, 라운드형 파티션 디자인을 선택하여 테이블, 소파, 조명으로 편안하고 안락한 공간에서 개인 업무 및 회의로 활용합니다.

Partitions can be chosen from straight and rounded types. Add a table, a sofa and a lighting to create a comfy space for individual work and meeting.



30T 파티션, 90도형 파티션, 120도형 파티션, 2인 라운드파티션 소파, 소파테이블

## 자유로운 회의 공간 Informal Meeting Space

편안한 분위기에서 회의하실 수 있는 소파로 구성된 미팅룸은 좋은 결과물을 창출해냅니다.

A meeting room with sofas that allow you to have a meeting in a comfortable atmosphere helps you produce great results.

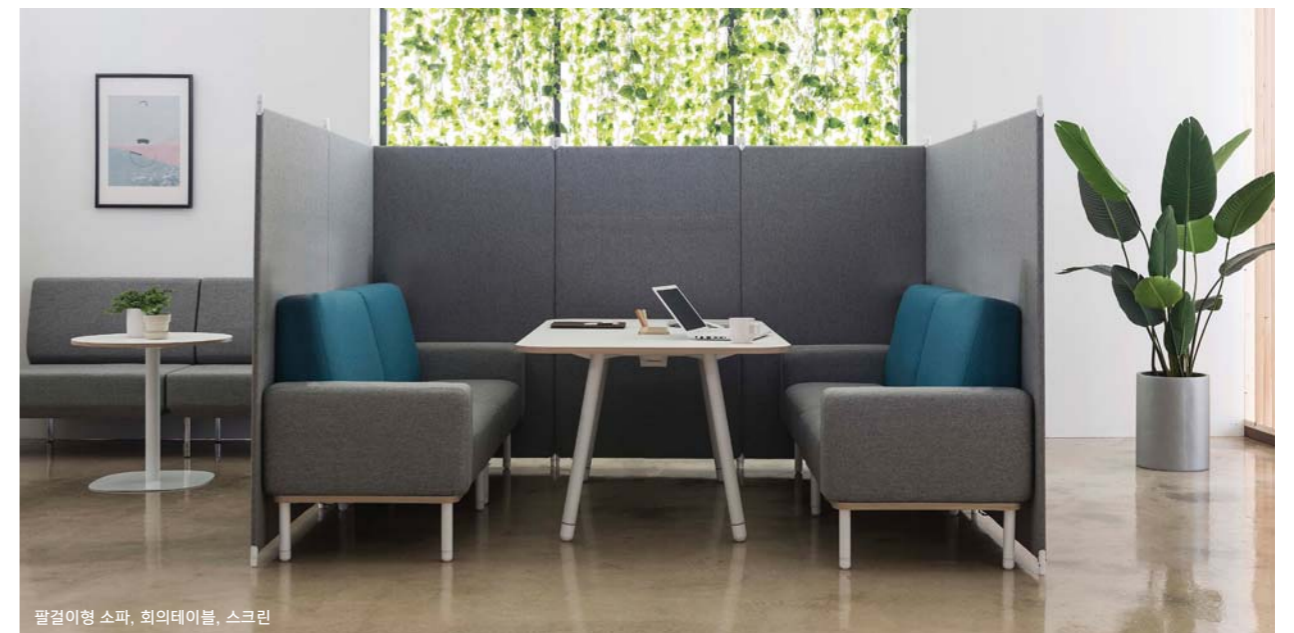

팔걸이형 소파, 회의테이블, 스크린

## 그룹 집중 공간 Group Focus Space

편안한 소파와 파티션으로 그룹회의를 자유롭게 할 수 있습니다.

You can have a group meeting in the meeting rooms made with partitions and comfortable sofas.



- 1 쿠션의 볼륨감과 자작나무 엷지를 믹스한 디자인은 따뜻한 느낌을 줍니다.
- 2 소파 하단부에 멀티탭을 설치하여 전자기기 사용이 편리합니다. (옵션품목)
- 3 유니크한 소파 등받이 라인은 공간 디자인의 스타일을 살려줍니다.

- 1 The design that mixes the volume of the cushion and the birch edge gives a warm feeling.
- 2 It is convenient to use electronic equipment because a multi tap is installed at the bottom of the sofa. (Optional item)
- 3 Unique sofa back lines enhance the style of the space design.

## C600 Group

공간별 특성에 맞춰 다양한 레이아웃 연출이 가능한 600G, 간결한 디자인으로 인테리어 연출을 도와줍니다.

600G, which can produce various layout according to the characteristics of space in any space. It is very easy to produce a layout that suits the design characteristics with no unnecessary.



90도형 파티션, 120도형 파티션, 육각 라운드파티션 소파, 등관형 라운드오픈 소파, 스톨형 라운드오픈 소파, 120도 파티션 데스크

## 개인 집중 공간 Individual Focus Space

주변의 시선이나 소음과 관계없이 개인만의 공간에서 집중해서 일하실 수 있습니다.  
You can focus on your personal space regardless of other people's attention or noise.

## C600 Group



600G 소파 600G Sofa  
Color. BU / GN / GY / RE  
900 · 700 · 840



600G 팔걸이소파 600G Armrest Sofa  
Color. BU / GN / GY / RE  
1100 · 700 · 840

\*좌형 (L Type)



600G 하이백 소파 600G High-Back Sofa  
Color. BU / GN / GY / RE  
900 · 700 · 1140



1인 라운드파티션 소파  
A Rounded Partition Sofa for a Single Person  
Color. BU / GN / GY / RE  
835 · 700 · 893



2인 라운드파티션 소파  
A Rounded Partition Sofa for Two Person  
Color. BU / GN / GY / RE  
1440 · 700 · 893



등판형 라운드오픈 소파  
A Rounded Sofa with a Backrest  
Color. BU / GN / GY / RE  
1000 · 800 · 735



육각 라운드파티션 소파  
Hexagonal Rounded Partition Sofa  
Color. BU / GN / GY / RE  
1430 · 700 · 893



600G 스톨소파  
600G Stool Sofa  
Color. GY  
1100 · 700 · 430



스툴형 라운드오픈 소파  
A Sofa Stool with Rounded Seat  
Color. GY  
1420 · 800 · 435



사각스툴 Stool  
Color. BU / GN / GY / RE  
420 · 420 · 420



하이바스틀 High Bar Stool  
Color. BU / GN / GY / RE  
350 · 385 · 854



로우바스틀 Low Bar Stool  
Color. BU / GN / GY / RE  
350 · 385 · 714

Color/Material



## C600 Group

### 30T Partition



스탠딩 파티션 라운드코너형 (H1350)  
Standing Partitions Round Corner (H1350)  
Color. GY  
600/700/800/1000/1200 · 30 · 1350



스탠딩 파티션 라운드코너형 (H1500)  
Standing Partitions Round Corner (H1500)  
Color. GY  
600/700/800/1000/1200 · 30 · 1500



90도형  
90-Degree Type  
Color. GY  
450 · 450 · 1350/1500



120도형 120-Degree Type  
Color. GY  
775 · 1350/1500



2구 2USB 타입 추가 전원  
2-outlet, 2-USB Type Additional Power  
\* 하부거치형 Under-mount Type  
\* 소파 하부 부착용



120도 파티션 데스크 120-Degree Partition Desk  
Color. SW  
1440 · 580 · 730



안정각 Stabilizer

Color/Material



GY / FABRIC

### Fabric Standing Partition



스탠딩파티션 W700 Standing Partitions W700  
Color. GY  
700 · 1500 · 26



스탠딩파티션 W900 Standing Partitions W900  
Color. GY  
900 · 1500 · 26



스탠딩파티션 W1100 Standing Partitions W1100  
Color. GY  
1100 · 1500 · 26



안정각 Stability Angle  
엔드 안정각 End Stability Angle  
중앙 안정각 Center Stability Angle

maas 마스



Working Lounge Sofa Series for Relaxation and Work

쉽도, 일도 잘 되는 워킹 라운지 디자인 소파 '마스' 시리즈

라운지 공간에서 휴식과 업무 모두 편안하게 할 수 있도록 인간공학적 설계가 반영된 '워킹 라운지' 전용 소파입니다. 디자인과 자연친화적인 원목 소재가 적용되어 공간을 보다 부드럽고 편안하게 만들어줍니다. This "Working Lounge" sofa is ergonomically designed for comfort in both relaxation and work within lounge spaces. It features a design with eco-friendly natural wood materials that make the space softer and more comfortable.



미들백 1인, 미들백 3인, 메인 테이블, 사이드 테이블

자연을 담은 유니크한 디자인으로 휴식과 협업이 가능한 워킹 라운지

공간의 컨셉에 맞추어 다양한 컬러 조합이 가능한 마스 라운지 소파, 원목 다릿발과 유니크한 테이블 디자인 조합으로 공간에 활기를 불어넣어주는 라운지를 연출해보세요.



### 캐주얼 네트워킹 라운지 Casual Networking Lounge

자유롭고 편안한 대화 속에서 팀간 활발한 의견 교환과 팀워크를 다질 수 있는 공간  
A space where active exchange of ideas and teamwork can be fostered through free and comfortable conversations



### 크리에이티브 미팅 라운지 Creative Meeting Lounge

구성원들과 함께 공동 작업을 하거나 외부 인원과 미팅이 가능한 공간  
A space for collaborative work among team members or meetings with external personnel

Working lounge designed for rest and collaboration, featuring a unique design that captures the essence of nature. Create a lively lounge that revitalizes the space with the Mass Lounge Sofa, which offers various color combinations tailored to the concept of the space, combined with wooden legs and a unique table design.



### 1인 집중 업무 공간 Single-User Focus Work Space

혼자 업무에 집중할 수 있도록 독립된 공간  
A separate space that allows for individual focus on work

\* 아이보리 컬러 : 고급 소재 원단(부클레 원단)



- 1 Leg Type : 동글동글한 원목과 모던한 스틸 마감의 다릿발 옵션으로 공간 컨셉과 분위기에 어울리는 매칭이 가능합니다.
- 2 Hard/Soft : 휴식과 집중의 사용 목적에 맞춰 좌판을 커스터마이징해 보세요.
- 3 카멜레온 패브릭 : 마스 소파만을 위한 카멜레온 원단으로 보는 각도에 따라 컬러가 오묘하게 변화합니다.
- 4 플로팅 베이스 디자인 : 마치 테이블 다리가 떠있는 듯한 유니크한 디자인 포인트로 가벼워 보이는 시각적 효과는 물론 공간 어느 곳에서도 잘 어울립니다.
- 5 감성과 기능을 갖춘 원목 테이블 : 따뜻하고 부드러운 감성을 지닌 예취 원목 상판으로 공간의 감성과 목적에 따라 다양한 활용이 가능합니다.

- 1 Leg Type: Options for round wooden legs and modern steel finishes are available, allowing for a matching that suits the concept and atmosphere of the space.
- 2 Hard/Soft: Customize the seat to suit your needs for relaxation and concentration.
- 3 Chameleon Fabric: Exclusive to the Mass Sofa, this fabric changes color subtly depending on the viewing angle.
- 4 Floating Base Design: With a unique design point that makes the table legs appear as if they are floating, it offers a visually light effect and fits well anywhere in the space.
- 5 Wooden Table with Emotional and Functional Features: The ash wood table, warm and soft to the touch, allows for versatile use depending on the emotional and functional needs of the space.



미들백 1인 Mid-Back 1 Person  
Color. IV / NV / OR / KH  
855 · 715 · 790



미들백 2인 Mid-Back 2 Person  
Color. IV / NV / OR / KH  
1415 · 715 · 790



미들백 3인 Mid-Back 3 Person  
Color. IV / NV / OR / KH  
1965 · 715 · 790



하이백 1인 High-Back 1 Person  
Color. IV / NV / OR / KH  
855 · 775 · 1115



하이백 2인 High-Back 2 Person  
Color. IV / NV / OR / KH  
1415 · 775 · 1115



하이백 3인 High-Back 3 Person  
Color. IV / NV / OR / KH  
1965 · 775 · 1115

Table 테이블

\* 컬러 : Amenity Table(243p)에서 확인



메인 테이블 Main Table  
Color. OR / MS / BK  
700 · 625 · 650



사이드 테이블 Side Table  
Color. OR / MS / BK  
465 · 300 · 650



필경대 옵션 Side Table Option  
Color. BE / BK  
360 · 250 · 670  
\* 1인, 2인 소파만 조합 가능

Color/Material

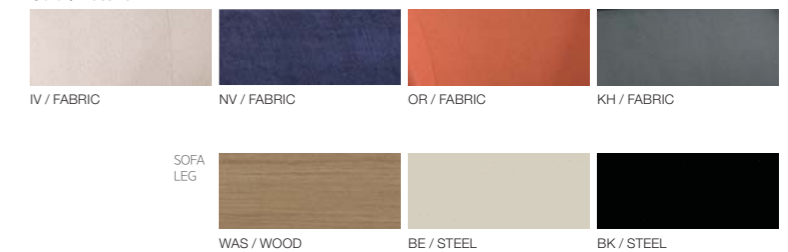

**nut** 누트



Modular working Sofa for Creative Office

#### 크리에이티브 오피스를 위한 모듈형 소파 '누트' 시리즈

어느 공간에나 매칭하기 좋은 심플한 디자인과 편안한 착석감을 가진 누트는 다양한 모듈 조합을 통해 라운지 공간을 목적에 맞춰 효율적으로 구성할 수 있습니다.

The nut features a simple design that matches any space and offers comfortable seating. Through various modular combinations, it can efficiently organize lounge areas according to their intended purpose.



## nut

작은 여유공간부터 넓은 라운지 공간까지 자유로운 조합형 모듈 가구

심플하게 정돈된 디자인과 부드러운 색감의 패브릭 컬러를 갖춘 두툽한 쿠션 구성의 누트 소파로 편안한 라운지를 경험해보세요.

Module furniture allowing for free combinations from small leisure spaces to large lounge areas

Experience a comfortable lounge with the Nut Sofa, featuring a simply organized design and thick cushions in soft fabric colors.



공간의 효율적 활용이 가능한 모듈 가구

### Efficient Use of Space with Modular Furniture

작은 여유 공간부터 넓은 공간까지 맞춤형 구성이 가능한 모듈형 소파. 공간의 크기나 구조에 구애 받지 않고 자유롭게 조합이 가능합니다.  
From small spare spaces to large areas, this modular sofa allows for customized configurations. It can be freely combined without being confined by the size or structure of the space.



### 심플하고 미니멀한 직선형 디자인과 따뜻한 색감 Simple and Minimalist Linear Design with Warm Colors

스탠딩 파티션과 테이블로 앉아서도 서서도 일할 수 있는 회의 공간은 효율을 올려줍니다.  
Standing partitions and tables allow for both seated and standing work, enhancing efficiency in meeting spaces.



### 폭신한 좌판과 허리를 제대로 받쳐주는 쿠션감 Plush Seating and Supportive Back Cushions

두툽한 좌판 쿠션과 허리라인에 맞춰 설계된 등판 쿠션으로  
장시간 앉아 있어도 편안합니다.  
Thick seat cushions and backrest cushions designed to  
align with the lumbar spine offer comfort even when  
sitting for long periods.



### 스마트 디바이스 충전 멀티탭 Smart Device Charging Multitap

스마트 디바이스 충전이 용이한 멀티탭을 옵션선택하여 사용할  
수 있습니다. (소파부착형/테이블 부착형)  
Opt for a multitap that facilitates the charging of smart  
devices, available as an attachment for either sofas or  
tables (sofa-attached/table-attached).

## Module Variation

### 4인 구성

1. 코너형(좌)+코너형(우)
2. 1인+코너형+1인



### 5인 구성

코너형(우)+1인(센터)+코너형(좌)



### 6인 구성

1인+코너형(우)+코너형(좌)+1인



### 7인 구성

1인+코너형(우)+1인(센터)+코너형(좌)+1인



### 8인 구성

엔드형(우)+코너형(우)+멀티탭 테이블세트  
+코너형(우)+엔드형(우)



## Table 테이블

\* 컬러 : Amenity Table(243p)에서 확인



사각 테이블 Square Table  
Color. BK / MS / OR  
750 · 550 · 660



원형 테이블 Round Table  
Color. BK  
500 · 500 · 660

## nut



미들백 1인 Mid-Back 1 Person  
Color. BE / MS / NV / GY  
Type. 엔드형 / 센터형  
630 · 690 · 765  
\* 엔드형 코너: R80



미들백 센터 2인 Mid-Back Center 2 Person  
Color. BE / MS / NV / GY  
Type. Left / Right  
1260 · 690 · 765



미들백 코너 Mid-Back Corner  
Color. BE / MS / NV / GY  
Type. Left / Right  
1320 · 690 · 765  
\* 우형(R Type)



미들백 콘센트 Mid-Back Socket  
Color. BE / MS / NV / GY  
1890 · 690 · 765  
\* 좌형(L Type)



미들백 3인 Mid-Back 3 Person  
Color. BE / MS / NV / GY  
1890 · 690 · 765



미들백 코너 3인 Mid-Back Corner 3 Person  
Color. BE / MS / NV / GY  
2010 · 690 · 765



하이백 엔드 High-Back End  
Color. BE / MS / NV / GY  
Type. 엔드형 / 센터형  
630 · 690 · 1015  
\* 엔드형 코너: R80



하이백 센터 2인 High-Back Center 2 Person  
Color. BE / MS / NV / GY  
Type. Left / Right  
1260 · 690 · 1015



하이백 코너 High-Back Corner  
Color. BE / MS / NV / GY  
Type. Left / Right  
1320 · 690 · 1015  
\* 우형(R Type)



하이백 콘센트 High-Back Socket  
Color. BE / MS / NV / GY  
1890 · 690 · 1015  
\* 좌형(L Type)



하이백 3인 High-Back 3 Person  
Color. BE / MS / NV / GY  
1890 · 690 · 1015



하이백 코너 3인 High-Back Corner 3 Person  
Color. BE / MS / NV / GY  
2010 · 690 · 1015

### Color/Material



BE / FABRIC

MS / FABRIC

GY / FABRIC

NV / FABRIC

SOFA  
LEG

WAS / WOOD

BK / STEEL

# RS2 201 Group



Infuse energy into space with unique designs.

유니크한 디자인으로 공간에 에너지를 불어넣다.

휴식공간, 회의공간으로 사용 가능한 소파구성으로 여러 가지 벤치 조합으로 다양한 공용공간을 연출할 수 있습니다. 직선을 기본으로 한 미니멀한 디자인과 따스한 색감은 공간을 부드럽게 바꿔드립니다.

A sofa configuration that can be used as a resting space or a meeting space allows you to create various public spaces with various bench combinations. A minimal design based on straight lines and warm colors will change the space soft.



벤치소파, 1인소파, 소파테이블



- 1 등받이 벤치로 회의 및 업무 시 더욱 편안한 자세로 이용 가능합니다.
- 2 바닥이 고르지 않은 장소에서 레벨러를 돌려 손쉽게 수평을 맞출 수 있습니다.
- 3 벤치, 등받이 벤치, 삼각벤치의 조합으로 다양한 공용 공간 구성이 가능합니다.



- 1 Backrest bench allows for a more comfortable posture for meetings and work.
- 2 You can easily adjust horizontality by turning the leveler in uneven areas.
- 3 A combination of a bench, a backrest bench and a triangular bench allows for a variety of common space configurations.

\*무재고 운영 그룹입니다

## RS2 201 Group



등받이형 Back Type  
Color. WG  
1600/2000 · 770 · 764



벤치형 Bench Type  
Color. WG  
1200/1600 · 770 · 380



삼각 벤치형 Triangle Bench Type  
Color. WG  
1100 · 780 · 380



코너 벤치형 Corner Bench Type  
Color. WG  
780 · 780 · 380

Color/Material



WG/ FABRIC

# RS1 100 Group



Fill the space with unique designs

## 유니크한 디자인으로 공간을 채우다

산뜻하고 화사한 파스텔 톤, 미니멀리즘의 심플한 디자인으로 탄생되어  
공간의 분위기를 몰라보게 변화시키는 모듈 시스템 소파.  
인체공학적 설계로 안락감 또한 뛰어난 시스템 소파입니다.  
The fresh bright pastel tones and minimalistic simple design of the  
module system sofa will completely change the atmosphere  
of the room. Its ergonomic design makes it very comfortable.



## RS1 100 Group

뛰어난 패션 감각을 느낄 수 있는 다채로운 컬러로 공간의 분위기가 몰라보게 달라집니다. 모듈형으로 제작되어 공간의 크기와 구조에 구애 받지 않고 원하는 대로 자유로이 조합, 설치할 수 있습니다.

Fabrics come in diverse lively and stylish colors. You can install or combine the module into any space or structure you desire.



2530×3290

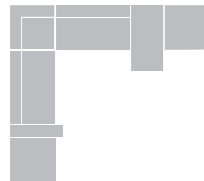

2400×4800



2400×2400



3460×3460

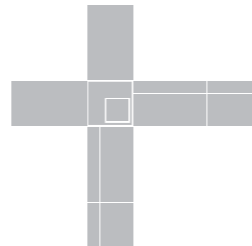

2360×2360

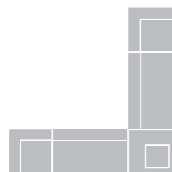

2360×4090

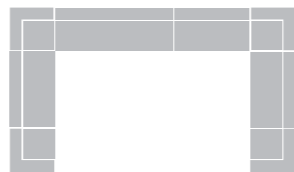

\*무재고 운영 그룹입니다

## RS1 100 Group



등받이형 코너형 Back Corner Type

Color. LG / GN(Fabric),  
IV+GN / IV+RE(Artificial Leather)

630 · 630 · 680



등받이형 내원형 Back Endarch Type

Color. LG / GN(Fabric),  
IV+GN / IV+RE(Artificial Leather)

1200 · 1200 · 680



등받이형 외원형 Back Exdarch Type

Color. LG / GN(Fabric),  
IV+GN / IV+RE(Artificial Leather)

1200 · 1200 · 680



스툴 코너형 Stool Corner

Color. LG(Fabric), IV(Artificial Leather)

630 · 630 · 400



스툴 반원형 Stool Semicircle Type

Color. LG(Fabric), IV(Artificial Leather)

1260 · 630 · 400



1인용 스툴 1 Person Stool

Color. LG(Fabric), IV(Artificial Leather)

630 · 630 · 400



2인용 스툴 2 Person Stool

Color. LG(Fabric), IV(Artificial Leather)

1100 · 630 · 400



1인용 1 Person

Color. LG / GN(Fabric),  
IV+GN / IV+RE(Artificial Leather)

630 · 630 · 680



2인용 2 Person

Color. LG / GN(Fabric),  
IV+GN / IV+RE(Artificial Leather)

1100 · 630 · 680



코너형 Corner Type

Color. LG / GN(Fabric),  
IV+GN / IV+RE(Artificial Leather)

630 · 630 · 680



파티션 Partition

Color. LG / GN(Fabric),  
IV+GN / IV+RE(Artificial Leather)

750/1100 · 170 · 800



파티션간 연결 브라켓  
A Partition Connecting Bracket

100 · 60 · 8

Color/Material

등판  
BACK

좌판  
SEAT

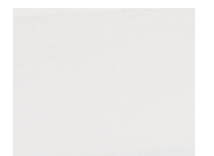
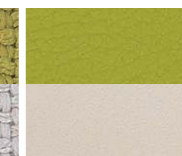

GN / FABRIC  
LG / FABRIC

GN / ARTIFICIAL LEATHER  
IV / ARTIFICIAL LEATHER

RE / ARTIFICIAL LEATHER  
IV / ARTIFICIAL LEATHER

SW / LPM

# Phone-Booth 폰부스



A focus booth that completes a smart office

## 스마트오피스를 완성하는 집중부스

프라이빗한 통화와 개인 업무를 지원하는 프리스탠딩 이동형 부스입니다.  
사용자의 취향과 공간에 어울리는 옵션으로 다양한 연출이 가능합니다.

It is a freestanding, movable booth that supports private calls and individual work, providing a private space. With options that suit the user's preferences and space, various arrangements are possible.



# Phone-Booth



- 1 물품을 올리거나 메모할 수 있는 편리한 선반 구성으로 형태와 색상 변경이 가능합니다.
  - 2 장시간 사용자를 고려하여 파워를 지원하며 콘센트와 USB 타입의 다양한 콘센트 조합 구성이 가능합니다.
  - 3 유압 도어로 부드럽고 조용히 닫히는 댐핑 기능을 갖췄습니다.
  - 4 내/외장 패브릭과 카펫 색상 선택 옵션을 제공합니다.
- 1 It allows for shape and color changes with a convenient shelf setup for placing items or taking notes.
  - 2 Designed for long-term users, it supports power with various combinations of outlets and USB types.
  - 3 Equipped with damping functionality for smooth and quiet closing with hydraulic doors.
  - 4 Offers options for internal/external fabric and carpet color selection.



- 1 국내 최초 이중 접합 차음 유리로 소음 차단 효과를 극대화하였으며, 후면 유리 및 패브릭 타입의 두가지 마감 옵션 선택이 가능합니다.
  - 2 재질 감지 기능으로 사용자 유/무 확인 및 자동 온/오프가 가능하고 내재된 환풍 기능으로 쾌적함을 유지합니다.
  - 3 캐스터 타입의 이동형 바퀴로 위치 변경이 용이합니다.
- 1 It is the first domestic product to utilize double laminated acoustic glass to maximize noise reduction, and it offers a choice between two types of finish options: back glass and fabric.
  - 2 Featuring an occupancy sensor function, it can detect the presence or absence of a user and enable automatic on/off, while the built-in ventilation feature maintains comfort.
  - 3 Position changes are easy with the mobile wheels of caster type.

## Phone-Booth



후면 목재형 Back Wood Type  
Color. BK / WH

966 · 1079 · 2251  
\* 주문시, 후면 마감 타입/패브릭 컬러 비교 기입  
\* 외부 패브릭 컬러 주문 제작 가능(상품기술서 확인)



후면 유리형 Back Glass Type  
Color. BK / WH

966 · 1079 · 2251  
\* 주문시, 후면 마감 타입/패브릭 컬러 비교 기입  
\* 외부 패브릭 컬러 주문 제작 가능(상품기술서 확인)

### Color/Material

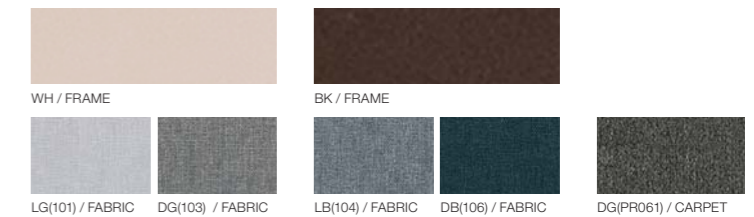

# EX900 Group



- 하부 자판에 무늬목은 소파를 견고하면서 분위기 있게 만들어 줍니다.
- 하부 다릿발은 스틸 소재로 적용하여 뛰어난 내구성을 갖추고 세련된 느낌을 주었습니다.

- The bottom panel with wood grain enhances the sofa's sturdiness and adds an atmospheric touch.
- The bottom panel with wood grain enhances the sofa's sturdiness and adds an atmospheric touch.

1인 1Person

1000 · 910 · 790

3인 3Person

2040 · 910 · 790



# Bake 베이크

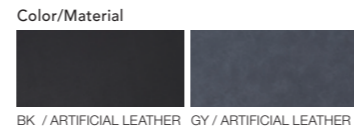

- 팔걸이와 다릿발 디자인과 마감을 독특하게 처리했습니다.
- 등 쿠션을 사용하여 착석 시 편안함을 느낄 수 있습니다.
- 다릿발 곡선 디자인으로 안정감과 부드러운 분위기를 연출합니다.

- The armrests and the legs are uniquely designed and finished.
- The back cushion provides comfort when seated.
- The curved design of the legs creates stability and a soft atmosphere.

1인 1Person

780 · 865 · 820

2인 2Person

1380 · 865 · 820

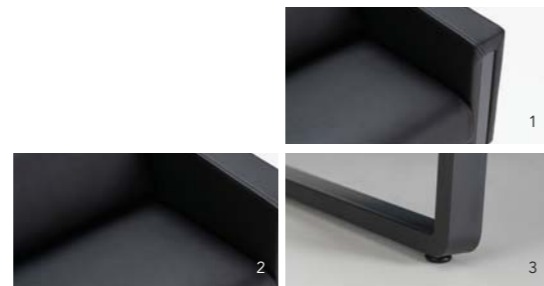

# RS7 700 Group

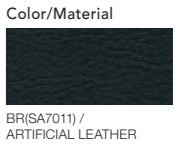

- 등받이 틸팅 기능을 넣어 사용자의 착석감을 높여줍니다.
- 크롬 도금의 다리를 사용하여 세련된 분위기를 연출합니다.
- 천연 가죽과 인조 가죽 사양을 선택할 수 있습니다.

- Adding a tilting function to the backrest enhances the user's seating comfort.
- Using chrome-plated legs creates a sophisticated atmosphere.
- Genuine leather and artificial leather options are available.

1인 1Person

900 · 760 · 680

3인 3Person

1800 · 760 · 680



# RS7 701 Group

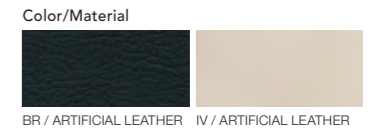

- 다리를 스틸로 사용하여 견고하며, 세련된 분위기를 연출합니다.
- 팔걸이와 좌판 사이의 마감을 독특하게 처리했습니다.
- 등 쿠션을 사용하여 착석 시 편안함을 느낄 수 있습니다.

- Using steel for the legs ensures sturdiness and creates a sophisticated atmosphere.
- The armrests and the seat are uniquely finished.
- The back cushion provides comfort when seated.

1인 1Person

780 · 760 · 580

2인 2Person

1380 · 760 · 580



# Hermoso 에르모소

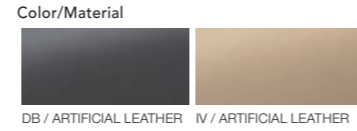

- 1 절제된 라인과 곡선을 시각적인 안정감을 줍니다.
- 2 이태리수입 밴드와 고밀도 스폰지를 통한 편안한 착석감과, 좌판부의 봉제 마감 디테일은 높은 디자인 완성도를 제공합니다.

- 1 Restrained lines and curves provide visual stability
- 2 Italian imported bands and high-density sponge ensure comfortable seating and stitched finish details on the seat provide a high level of design completion.

1인 1Person  
820 · 810 · 700

2인 2Person  
1400 · 810 · 700

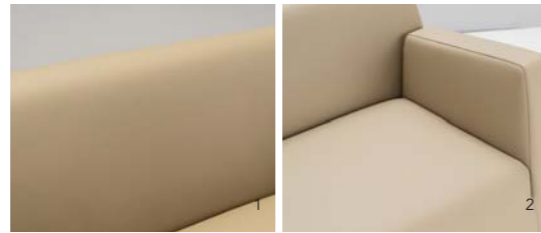

# 3200 Group

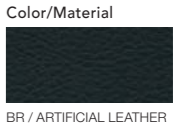

- 1 등판과 좌판에 인조 가죽을 적용했습니다.
- 2 자연스러운 곡선의 팔걸이로 디자인했습니다.

- 1 Artificial leather is applied to the backrest and seat cushion.
- 2 The armrests are designed with natural curves.

1인 1Person  
850 · 830 · 850

3인 3Person  
1830 · 830 · 850



# Nieve 니에베



- 1 부드러운 엣지 마감을 통해 편안한 착석감을 제공합니다.
- 2 세 가지 컬러를 활용하여 다양한 분위기를 연출할 수 있습니다.
- 3 소파 하부의 글라이더를 통해 사용성을 높였습니다.

- 1 Soft edge finishing ensures a comfortable and stable seating experience.
- 2 Various atmospheres can be created using three different colors.
- 3 Enhanced usability is achieved through gliders at the bottom of the sofa.

1인 1Person  
610 · 570 · 670



# RS3 300 Group

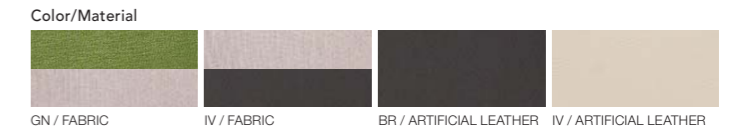

- 1 심플한 디자인으로 다양한 공간 구성이 가능합니다.
- 2 투톤의 컬러 조합으로 편안한 분위기를 제공합니다.

- 1 With its simple design, it allows for various spatial arrangements.
- 2 Two-tone color combinations provide a comfortable atmosphere.

1인 1Person  
610 · 630 · 780



# Mocha 모카



Color/Material



- 1 충분한 쿠션감을 제공하여 편안하고 폭신한 착석감을 제공합니다.
- 2 의자를 감싸 안고 있는 프레임은 시각적으로 심리적 안정감을 줍니다.
- 3 하부 글라이더는 이동시 바닥 긁힘을 방지합니다.

- 1 The ample cushioning offers comfort and paddedness.
- 2 The frame surrounding the chair provides visual and psychological stability.
- 3 The bottom gliders prevent floor scratches during movement.

1인 1Person

600 · 680 · 815



# LH 200 Group



Color/Material



- 1 Bridge Type 구조로 간결하고 안정적인 다릿발입니다.
  - 2 마이크로라인 HPM을 적용한 테이블로 사용자의 편의를 고려했습니다.
- 1 The armrests and the legs are uniquely designed and finished.
  - 2 The back cushion provides comfort when seated.

로비의자 Lobby Chair

1600 · 610 · 410  
1600/1700 · 650 · 887



# Amenity Table

소통과 휴식을 위한 어메니티 테이블 구성으로 공간과 용도에 따라 활용할 수 있습니다.  
Amenity tables designed for communication and relaxation can be utilized according to the space and purpose.

## Sofa Table(Low-Height)

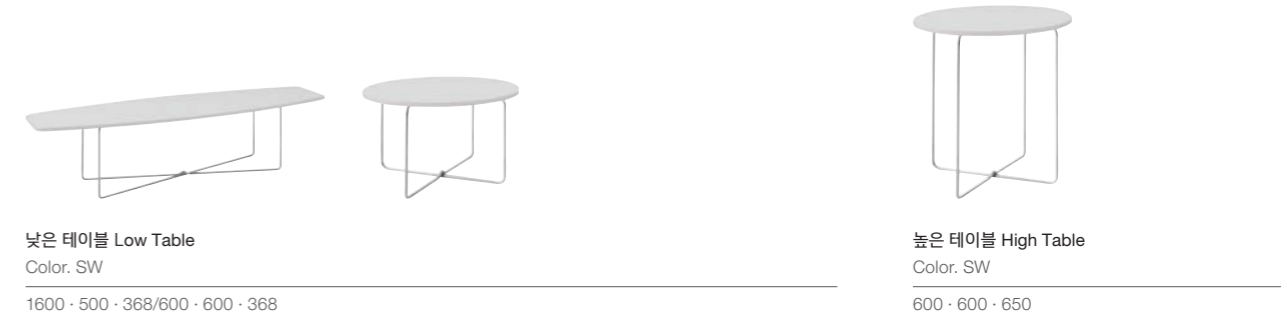

낮은 테이블 Low Table

Color. SW

1600 · 500 · 368/600 · 600 · 368



높은 테이블 High Table

Color. SW

600 · 600 · 650



낮은 테이블 Low Table

Color. IV

900 · 900 · 355



높은 테이블 High Table

Color. LG / WG

580 · 580 · 420



티테이블(대/소) Tea Table(Large/Small)

Color. WOA

1030 · 770 · 353/ 600 · 619 · 423



낮은 테이블 Low Table

Color. IV

694 · 694 · 350



테이블 Table

Color. LG / WG

427 · 427 · 550



테이블 Table

Color. WG

595 · 334 · 500

Color/Material



## Amenity Table

### Sofa Table(Mid-Height)



**유리 테이블 Glass Table**  
Color. 투명  
Frame. SW  
620 · 620 · 450



**사각 테이블 Square Table**  
Color. SW  
Frame. SW  
750 · 750 · 450/550 · 550 · 450  
\* 화이트 엣지 White Edge



**사각 테이블 Square Table**  
Color. SW  
Frame. SW  
750 · 750 · 660/550 · 550 · 660  
\* 화이트 엣지 White Edge



**소파테이블 Sofa Table**  
Color. SW  
Frame. SW  
550/750/900 · 550 · 660  
\* 우드 엣지 Wood Edge



**원형 테이블 Round Table**  
Color. SW  
Frame. SW  
700 · 700 · 660  
\* 우드 엣지 Wood Edge

### Color-Base Table



**원형 테이블 Round Table**  
Color. SW  
Frame. BK  
550 · 500 · 660



**사각 테이블 Square Table**  
Color. SW  
Frame. OR / MS / BK  
750 · 550 · 660

### Wood Table



**라운드 원목 테이블 Round Solid Wood Table**  
Color. WAS  
Frame. OR / MS / BK  
700 · 625 · 650



**사이드 원목 테이블 Side Solid Wood Table**  
Color. WAS  
Frame. OR / MS / BK  
465 · 300 · 650

#### Color/Material



## Amenity Table

### Multi-Purpose Table



**사각회의테이블(기본형/덕트형) Square Shape Table(Standard/Duct Type)**  
Color. SW  
1800 · 1000 · 730  
\* 우드 엣지 Wood Edge



**타원회의테이블 Ellipse Shape Table**  
Color. SW  
1800 · 1000 · 730  
\* 우드 엣지 Wood Edge



**조합형회의테이블 Combined Shape Table 타원+원형 Ellipse+Circle/사각+원형 Square+Circle**  
Color. SW  
2620 · 1000 · 730  
\* 우드 엣지 Wood Edge



**스탠딩테이블(단식/복식) Standing Table(Single/Double)**  
Color. SW  
1600 · 450/900 · 1050  
\* 우드 엣지 Wood Edge



**원형 스탠딩 테이블 Round Standing Table**  
Color. SW  
1200 · 910  
\* 우드 엣지 Wood Edge



**회의테이블 Conference Table**  
Color. SW  
1800 · 900 · 730  
\* 우드 엣지 Wood Edge



**스탠딩 테이블 Standing Table**  
Color. SW  
550 · 550 · 1050  
\* 우드 엣지 Wood Edge



**이동형 스탠딩테이블 Movable Standing Table**  
Color. WQA  
800 · 600 · 950



**TV스탠드 TV Stand**  
804 · 604 · 1346  
\* 적용범위: 40~50인치 TV (50인치 초과 시 담당자와 별도 협의가 필요합니다.)

#### Color/Material





## Brand

해이워스는 1948년 미국에서 설립된 브랜드로 75년간 혁신적인 사무용 가구 디자인과 제작을 선도해온 글로벌 기업입니다. 연 매출 약 3조원을 기록하며, 북미 사무가구 시장의 TOP3 에 속하는 브랜드 입니다.

HAWORTH, founded in 1948 in the USA, is a global company that has led innovative office furniture design and manufacturing for 75 years. It records an annual revenue of about 3 trillion KRW, ranking among the top three brands in the North American office furniture market.



## Sustainability 인증 및 수상 이력

지속가능성 - 제품 환경 데이터(PED) 및 관련 인증

Material	Material Weight	
Plastic	10.3kg	(67%)
Steel	3.3kg	(21%)
Foam	1.2kg	(8%)
Fabric	0.7kg	(4%)
<b>Total</b>	<b>15.4kg</b>	<b>(100%)</b>

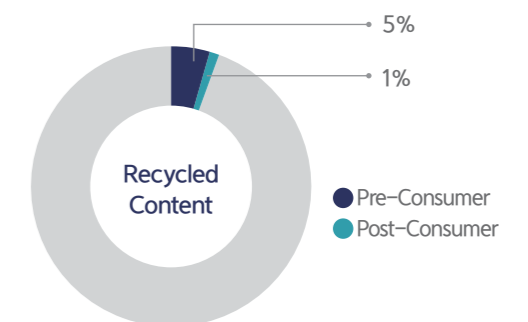

BIFMA Level 2 certified (Chinese plant)  
Certification # SCS-SCF-08448

INDOOR AIR QUALITY  
certification # SCS-IAQ-09818

Greenguard Gold certified  
Certification # 139803-420

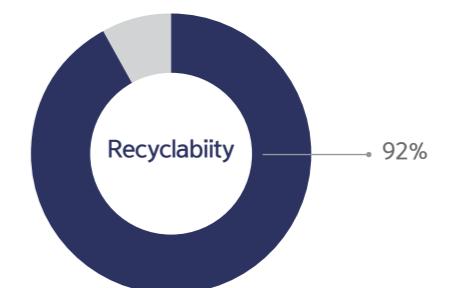

# FERN 편

Fern은 사용자의 움직임에 따라 반응하는 등받이의 유연한 4중 구조가 목부터 요추까지 완벽한 균형과 편안함을 제공합니다.

FERN provides perfect balance and comfort from the neck to the lumbar region with its flexible quad structure backrest that reacts to the user's movements.



## 웨이브 서스펜션 시스템 Wave Suspension System

### 1 렘버 서포트 Lumbar support

렘버 서포트의 위치를 조절할 수 있습니다. (범위 10cm)

### 2 4D 암레스트 4D Armrest

4방향으로 팔걸이 조절이 가능하여 편리한 사용감을 제공합니다.

### 3 틸팅 텐션 & 5단계 각도 조절

Tilting Tension & 5-level Angle Adjustment

등받이를 뒤로 젖힐 때 느껴지는 저항을 미세하게 조절이 가능합니다.

### 4 포워드 틸팅 & 좌판 깊이 조절

Forward Tilting & Seat Depth Adjustment

좌판을 약 5° 앞으로 기울일 수 있으며 몸에 맞는 깊이 조절이 가능합니다.

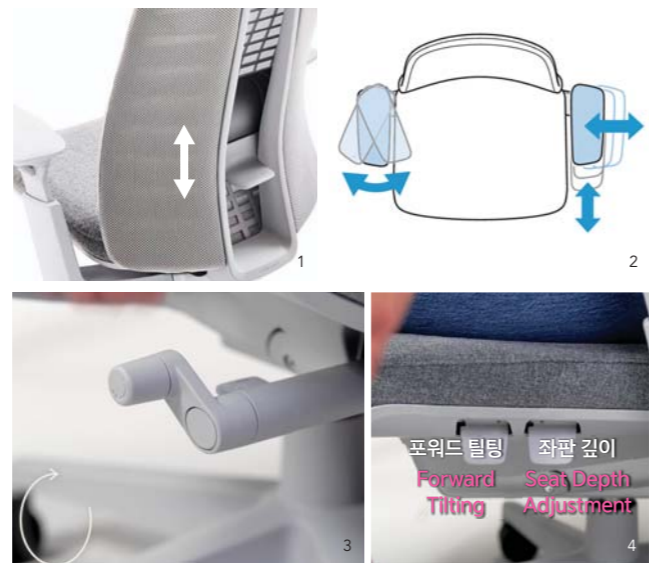

# ZODY2 조디2

ZODY2는 인체공학적 혁신과 현대적인 디자인을 담고 있습니다.

인체공학적 연구와 디자인 발전을 통합하여 뛰어난 편안함과 지지력을 갖춘 사무실 의자를 제공합니다.

ZODY2 contains ergonomic innovation and modern design. It offers office chairs with exceptional comfort and support, integrating ergonomic research and design advancement.



Public

Amenity

HAWORTH

### 1 PAL 시스템 (고급형) PAL System (Advanced)

미국 물리치료협회의 승인 및 특허를 받은 골반 및 요추지지 렘버 시스템, 높이 조절 외 좌 우 텐션 개별 조절이 가능합니다.

### 2 4D 암레스트 4D Armrest

4방향으로 팔걸이 조절이 가능하여 편리한 사용감을 제공합니다.

### 3 틸팅 텐션 조절 Tilting Tension Adjustment

등받이를 뒤로 젖힐 때 느껴지는 저항을 미세하게 조절/잠금이 가능합니다.

### 4 듀얼 포스처 & 락 기능 (고급형)

Dual Posture & Lock Feature (Advanced)

포워드 틸팅을 포함하는 듀얼 포스처 기능을 통해 걸쳐 앉는 자세까지 지원합니다.



# ZODY LX 조디 엘엑스

ZODY LX는 자연에서 영감을 받은 형태로, 인체공학적 편안함을 제공하며, 전체 패브릭 마감을 통해 풍부한 볼륨감과 차별화 되는 룩을 제안합니다.

ZODY LX is inspired by nature, offering ergonomic comfort and proposing a distinctive look with a full fabric finish.

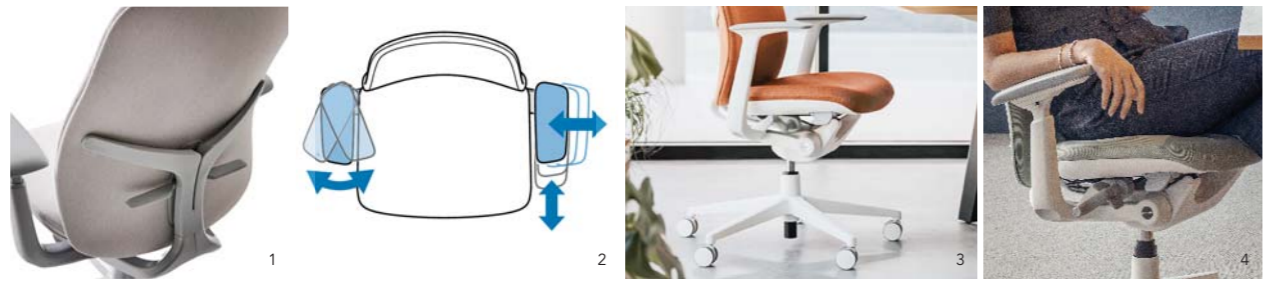

- ❶ 럼버 서포트**  
Lumbar Support  
위아래로 움직여 높이 조절이 가능합니다.
- ❷ 4D 암레스트**  
4D Armrests  
4방향으로 팔걸이 조절이 가능하여 편리한 사용감을 제공합니다.
- ❸ 틸팅 텐션 & 5단계 각도 조절**  
Tilting Tension & 5-Level Angle Adjustment  
등받이를 뒤로 젖힐 때 느껴지는 저항을 미세하게 조절이 가능합니다.

- ❹ 듀얼 포스처 & 좌판 깊이 조절**  
Dual Posture & Seat Depth Adjustment  
좌판을 약 5° 앞으로 기울일 수 있으며 몸에 맞는 깊이 조절이 가능합니다.

## HAWORTH

\* 마감재 별도 선택 가능

### FERN



미들백 타입 Mid-Back Type  
Finish. MESH+FABRIC  
W737 D724 H1058-1158



헤드레스트 타입 Headrest Type  
Finish. MESH+FABRIC  
W737 D724 H1058-1158

### ZODY2



미들백 타입 Mid-Back Type  
Finish. MESH+FABRIC  
W737 D737 H965-1092



헤드레스트 타입 Headrest Type  
Finish. MESH+FABRIC  
W737 D737 H977 - 1118

### ZODY LX



ZODY LX  
Finish. FABRIC  
W737 D737 H1024-1194

## Office Workplace Materials

### OA Common Color



Voluto	○	○	○	
Easy Linker	○	○	○	
Lite Space	○	○		
E-MOTION DESK	○		○	○
DRAWERS	○	○	○	○
WARDROBE	○	○	○	
CABINET	○	○	○	

### OA-Sole Color

#### E-MOTION DESK

SIGNATURE DESK



#### 002G

LOCKER STORAGE CLOSET

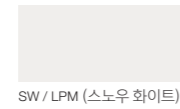

#### SCREEN

FABRIC [ COMMON ]



FABRIC [ E-MOTION DESK ]



FELT [ COMMON ]



#### 30T Partition



## Office Workplace Materials

### Conference-Common Color



HC5 500 Group (독립형/조합형)	○	○	○
Voluto	○	○	○
Office-One	○	○	○
Hub-T	○	○	○
SWING	○		

#### EC9 900 Group



#### HC7 700 Group

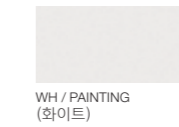

#### CLECS

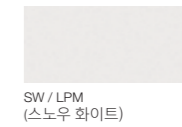

### Executive Color

#### RESERVA

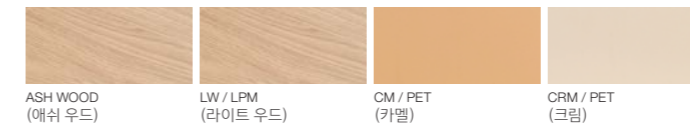

#### EX9 900 Group



#### CUERNO



#### Office-One



#### MONTER



## Business Area

### 직영전시장 Direct Management Showrooms



#### 송파전시장 Songpa

서울특별시 송파구 송이로 136 폭스바겐 빌딩 3, 4층  
3rd and 4th Floors, Volkswagen Building, 136, Songji-ro, Songpa-gu, Seoul  
Tel. 02-6486-3332 | 82-2-6486-3332



#### 강서전시장 Seoul Gangseo

서울시 강서구 화곡로 292  
292, Hwagok-ro, Gangseo-gu, Seoul  
Tel. 02-2606-3332 | 82-2-2606-3332



#### 부산전시장 Busan

부산광역시 해운대구 해운대로 743 5층  
5th Floor, 743, Haeun-daero, Haeundae-gu, Busan  
Tel. 051-791-0710 | 82-51-791-0710



#### 대전전시장 Daejeon

대전광역시 대덕구 계족로 552 1,2층 운영사무실  
1st and 2nd floors, Operating Office, 552, Gyejok-ro, Daedeok-gu, Daejeon  
Tel. 042-710-0760 | 82-42-710-0760



#### 광주전시장 Daejeon

광주광역시 서구 상무대로 903 5층  
5F, 903 Sangmu-daero, Seo-gu, Gwangju  
Tel. 062-384-4847 / 82-62-384-4847

### 공식 전시장 Official Showrooms



#### 하남 공식 전시장 Hanam

경기도 하남시 초이로 23, 3층  
3F, 23 Choi-ro, Hanam-si, Gyeonggi-do  
Tel. 02-540-3693 | 82-2-540-3693



#### 대구 공식전시장장 Buk-gu, Daegu

대구광역시 북구 동북로 35(산격동)  
Tel. 053-381-1114



#### 천안 공식 전시장 Cheonan

충청남도 천안시 서북구 4산단로 28(성성동)  
Tel. 041-621-8500

### 거점전시장 Regional Showrooms



#### 포항 거점 전시장 Pohang

경상북도 포항시 남구 대잠동 903-10번지  
Tel. 054-277-8272



#### 광주 광산 거점 전시장 Gwangsan-gu, Gwanju

광주광역시 광산구 평동산단로 170-3, 1층  
Tel. 062-364-4600



#### 부산 동구 거점 전시장(좌천점) Dong-gu, Busan

부산광역시 동구 좌천동 404-3  
Tel. 051-635-3755



#### 대전 대덕 거점 전시장(중리점) Daedeok-gu, Daejeon

대전광역시 대덕구 한밭대로 1201 대성빌딩 1, 2층  
Tel. 042-301-7262



#### 광주 북구 거점 전시장(금실방점) Buk-gu, Gwangju

광주광역시 북구 중가로 3번길 10  
Tel. 062-525-2630

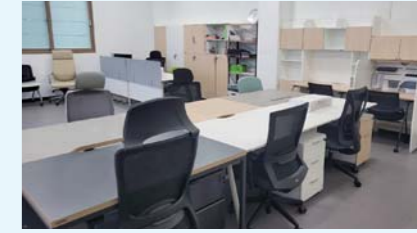

#### 부산 강서 거점 전시장 Gangseo-gu, Busan

부산광역시 강서구 명지국제6로 314 3층  
Tel. 051-941-4041



#### 전주 거점 전시장(센텀하우스점) Jeonju

전라북도 전주시 완산구 백제대로 434  
Tel. 1577-5427



#### 광주 서구 거점 전시장(굿모닝점) Seo-gu, Gwangju

광주광역시 서구 하남대로 564(동천동)  
Tel. 062-513-8060



#### 목포 삼호 거점전시장 Mokpo

전라남도 영암군 삼호읍 녹색로 600  
Tel. 061-461-0444



#### 을지 거점 전시장 Eulji

서울특별시 중구 창경궁로 31, 1~2층  
1~2F 31, Changgyeongung-ro, Jung-gu, Seoul  
Tel. 02-2135-2700 | 82-2-2135-2700

### 본사 사무소 Head Offices

#### 서울사무소 Seoul

서울시 강남구 압구정로 201  
201, Apgujeong-ro, Gangnam-gu, Seoul  
Tel. 02-3480-6624, 7975

#### 울산사무소 Ulsan

울산광역시 북구 명촌 10길 62  
62, Myeongchon 10-gil, Buk-gu, Ulsan  
Tel. 052-289-4358

#### 광주사무소 Gwangju

광주광역시 서구 상무대로 903  
903, Sangmu-daero, Seo-gu, Gwangju  
Tel. 062-941-9600

#### 대전사무소 Deajeon

대전광역시 대덕구 계족로 552  
552, Gyejok-ro, Daedeok-gu, Daejeon  
Tel. 042-710-0760

## C/S & Contact Us



서울·경인지역 / 원주·강원지역  
대전·충청지역 / 전북(전주이북)지역  
02-3480-6624

Seoul-Gyeongin Area  
Wonju-Gangwon Area  
Daejeon-Chungcheong Area  
Jeonbuk(north of Jeonju) Area  
82-2-3480-6624



대구·경북지역  
부산·울산·경남지역  
052-289-4358

Daegu-Gyeongbuk Area  
Busan-Ulsan-Gyeongnam Area  
82-52-289-4358



광주·전남지역  
전북(전주이남)지역 / 제주도  
062-941-9600

Gwangju-Jeonnam Area  
Jeonbuk(south of Jeonju) Area  
Jeju-do  
82-62-941-9600

### 전국 C/S안내 National C/S Center

#### 본사 Headquarters

경기도 용인시 처인구 남서면 경기동로 316  
316 Gyeonggi-dong-ro, Namsa-myeon, Cheoin-gu,  
Yongin City, Gyeonggi-do

#### 서울사무소 Seoul Office

서울시 강남구 압구정로 201(금강소평센터) 2F  
201, Apgujeong-ro, Gangnam-gu, Seoul

#### 소비자상담실 Customer Service Center

1577-3332  
82-1577-3332

#### 대리점 개설상담/제품 구매

##### New Dealership Consultation / Product Purchase

오피스영업팀(경인)	02-3480-8295
오피스영업팀(울산)	052-289-4358
오피스영업팀(광주)	062-941-9600
Office Sales Team(Gyeongin)	82-2-3480-8295
Office Sales Team(Ulsan)	82-52-289-4358
Office Sales Team(Gwangju)	82-62-941-9600

#### 수출관련 Export Consultation

해외영업팀	02-3480-6626, 6627
Overseas Sales Team	82-2-3480-6626, 6627

## Global Network



### Contact Us

#### General Management

T. 82-2-3480-6626  
F. 82-2-6442-8208  
E. freemk79@hyundaiivart.co.kr

#### Asia & Others

T. 82-2-3480-8956  
F. 82-2-6442-8208  
E. yr0603@hyundaiivart.co.kr

#### Middle East & Africa

T. 82-2-3480-6631  
F. 82-2-6442-8208  
E. pack.livart@hyundaiivart.co.kr

#### America & Oceania

T. 82-2-3480-6630  
F. 82-2-6442-8208  
E. parkjh1412@hyundaiivart.co.kr

서울사무소 서울시 강남구 압구정로 201 Tel. 02-3480-6624  
강서전시장 서울시 강서구 화곡로 292 Tel. 02-2606-3332  
송파전시장 서울시 송파구 송이로 136 Tel. 02-6486-3332  
부산전시장 부산광역시 해운대구 해운대로 743 Tel. 051-791-0710  
대전전시장 대전광역시 대덕구 계족로 552 Tel. 042-710-0760  
울산전시장 울산광역시 북구 명촌 10길 62 Tel.052-289-4358  
광주전시장 광주광역시 서구 상무대로 903 Tel.062-941-9600

[www.hyundailivart.co.kr](http://www.hyundailivart.co.kr)



e-카탈로그 접속



- 본 카탈로그에 수록된 사진은 실물과 다를 수 있으므로 구입 전 반드시 확인하시기 바랍니다.
- 표시된 규격, 디자인은 설계 및 생산공정상 변경될 수 있습니다.
- The photos in this catalog can differ from actual furniture.  
Be sure to check actual furniture before purchase.
- The sizes and designs indicated here are subject to change depending on situations involved with product design and manufacturing.



제작일 : 2026년 5월 발행  
Date of Publication : May 2026